

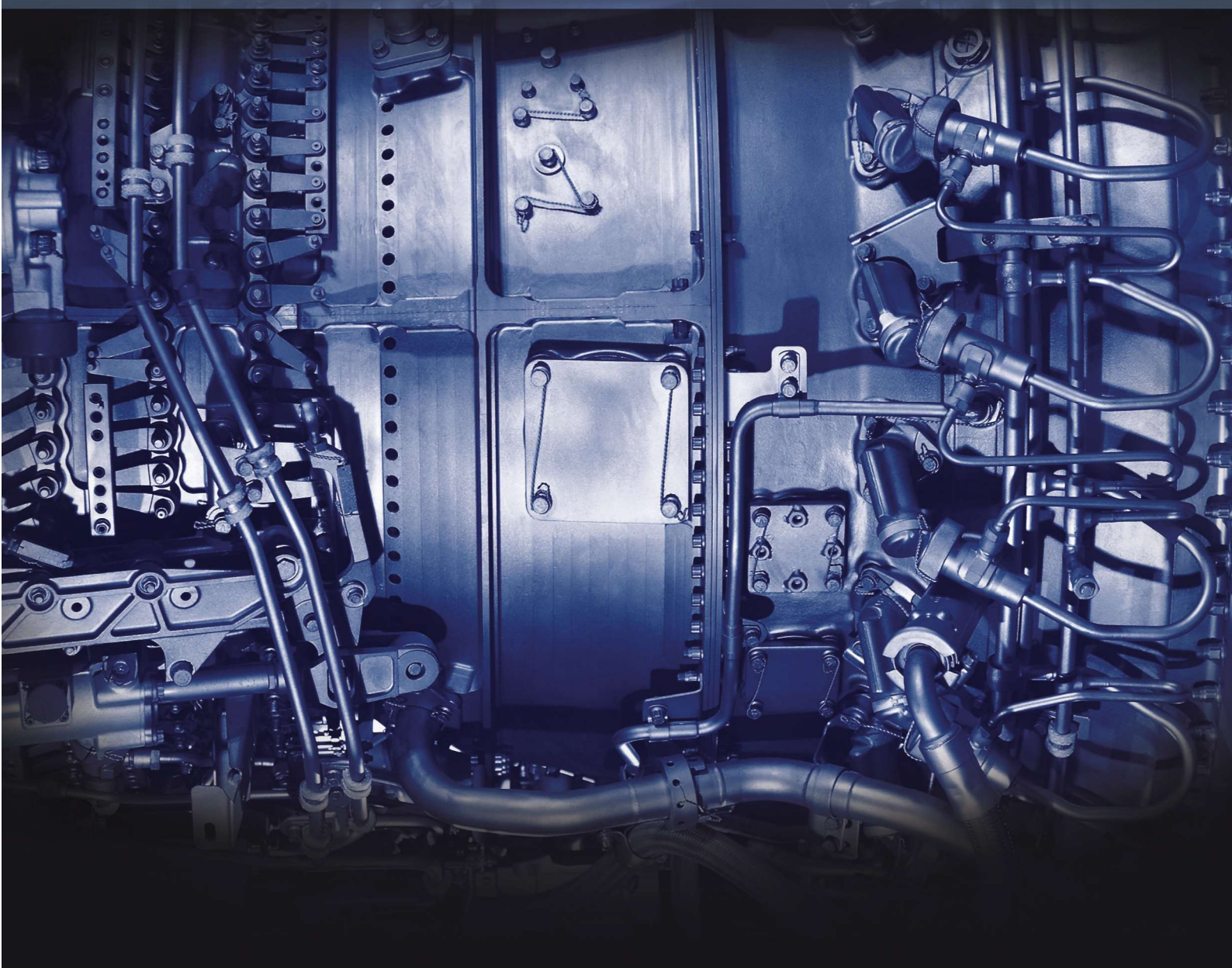

Simplifying Electricity

EASA - Electronic Fundamentals 1



CP7419

MATRIX
www.matrixmultimedia.com

Copyright © 2010 Matrix Multimedia Limited

Worksheet 1 - Testing a diode	3
Worksheet 2 - Diode characteristics	5
Worksheet 3 - Diode clipping	7
Worksheet 4 - Diode clamping	9
Worksheet 5 - Half-wave rectifier	11
Worksheet 6 - Full-wave (bridge) rectifier	13
Worksheet 7 - Voltage multiplier	15
Worksheet 8 - Thyristor	17
Worksheet 9 - Zener diode characteristics	19
Worksheet 10 - Zener diode voltage regulator	21
Worksheet 11 - Light emitting diodes	23
Revision Questions	25
Tutor's notes	30
Answers	36

Developed by Mike Tooley in conjunction with Matrix Technology Solutions Ltd

Worksheet 1

Testing a diode

Diodes allow current to flow in one direction but not in the other. This leads to useful applications including rectification - converting alternating current (AC) to direct current (DC).

The diode's properties come from the behaviour of the PN junction, where N-type behaviour meets P-type.

The ideal diode conducts perfectly in one direction and not at all in the other. In practice, diodes offer extremely low resistance to current flow in one direction and extremely high resistance in the other. This is summarised in the diagram below:



w1a

Over to you:

- Connect the circuit shown in (a). Here, the diode is forward-biased.
- Set the DC power supply to output 4.5V.
- Set the multimeter so that it reads 200mA DC full-scale.
- Measure the current flowing and record it in the table.
- Next, reverse the diode, as shown in (b). Now the diode is reverse-biased.
- Again measure and record the current flowing. (You need to change to a more sensitive current range.)
- Finally, for comparison purposes, make the same measurements on firstly a short-circuit, as in (c), and an open-circuit, as in (d).
- Again, record these measurements in the table.

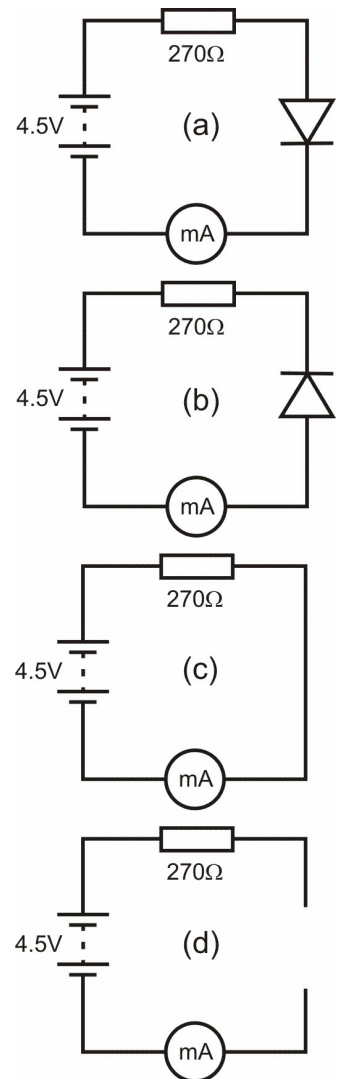

w1c

Circuit	Measured current
(a) Forward bias	
(b) Reverse bias	
(c) Short-circuit	
(d) Open-circuit	

Worksheet 1

Testing a diode

So what?

- What do the results tell you about the resistance of the diode?
- Does it conduct perfectly in the forward direction? Was it as good as a short-circuit?
- Does the diode conduct at all in the reverse direction? Was it as good as an open-circuit?

Write a summary of your findings.

For your records:

In the forward direction, (when the anode of the diode is more positive than the cathode,) a large current flows.

In the reverse direction, (when the cathode is more positive than the anode) no current at all should flow.

Forward bias	<p>To positive terminal of power supply</p> <p>anode</p> <p>cathode</p> <p>To negative terminal of power supply</p>	<p>Current can flow in this direction (Low resistance)</p>
Reverse bias	<p>To negative terminal of power supply</p> <p>anode</p> <p>cathode</p> <p>To positive terminal of power supply</p>	<p>Tiny current in this direction (High resistance)</p>

w1d

Three ways to test a diode:

- use a multimeter with a diode-check facility;
- measure the forward and reverse resistance of the diode using a multimeter on the resistance (ohms) range.
- connect a diode to a power supply and measure the current flowing in either direction. (This is the approach you took in the investigation.)

Worksheet 2

Diode characteristics

A more meaningful measure of the performance of a diode comes from plotting a graph of forward and reverse current against the applied voltage. This allows us to predict accurately how the diode will behave in a particular circuit, and show whether or not it is suitable for that application.

In this worksheet you compare the characteristics of two different diodes. One is a general purpose low-voltage silicon diode (1N4001) whilst the other is a shottky diode.

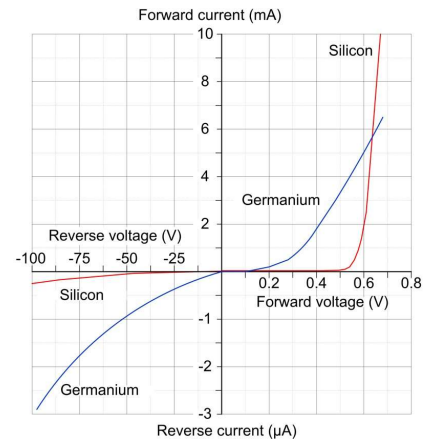

Over to you:

- Build the circuit shown opposite, to allow you to measure the **forward** characteristics of the diodes.
- Set the DC power supply for an output of 4.5V.
- Set the voltmeter to the 20V DC range and the ammeter to the 20mA DC range.
- Use the 'pot' to vary the voltage, V_F , applied to the diode from 0.1V to 0.7V in steps of 0.1V.
- At each step, measure and record the forward current, I_F , in the table.
- Repeat this procedure for the other diode.
- Next invert the diode, and change the power supply voltage to 12V, as shown in the lower diagram, .This allows you to measure the **reverse** characteristics of the two diodes.
- Change the ammeter to the 200 μ A DC range.
- Once again, use the 'pot' to vary the voltage applied to the diode, now called V_R , but this time you will only need to take current readings, I_R , at 0V, 5V and 10V.
- Record them in the table.
- Repeat the process for the other diode.

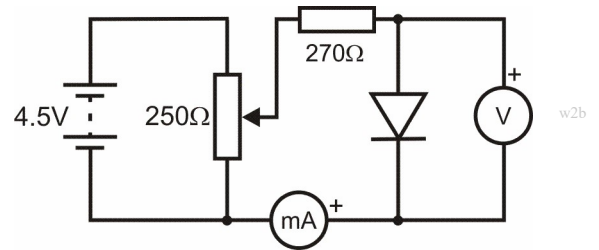

Forward characteristics		
V_F	I_F - 1N4001	I_F - Shottky
0		
0.1		
0.2		
0.3		
0.4		
0.5		
0.6		
0.7		

Reverse characteristics		
V_R	I_R - 1N4001	I_R - Shottky
0		
5.0		
10.0		

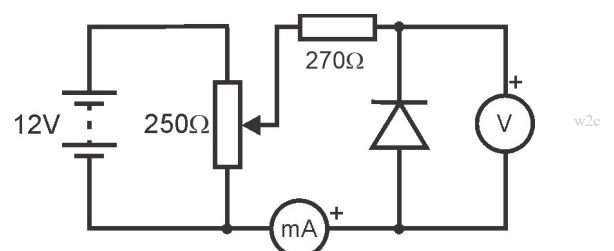

Worksheet 2

Diode characteristics

So what?

- Use the axes provided to plot your results as a graph of applied voltage against current for both the forward and reverse directions and for both diodes.

Notice that the voltage and current scales are different for the two directions.

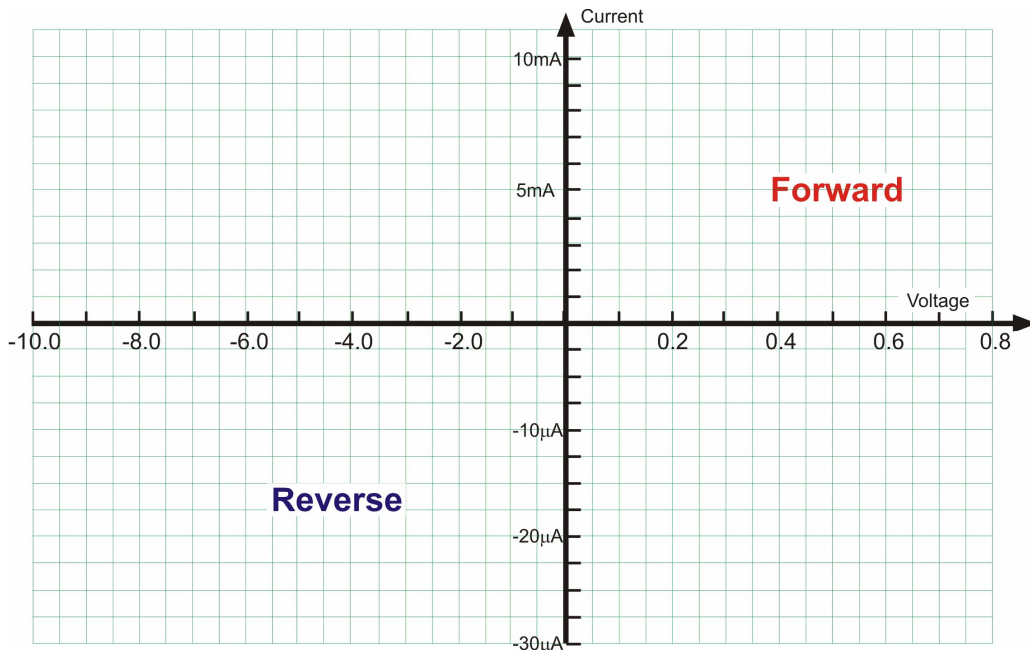

- Describe what these graphs tell you about the behaviour of the two kinds of diode.
- What forward voltage is required to make each of the diodes begin to conduct?

Silicon

Shottky

For your records:

- Diodes are usually made from semiconducting crystals. The behaviour of the device depends on the material it is made from, as the graph shows.
- The diode is a 'one-way valve'. It allows a current to flow through it in only one direction. (A resistor behaves in exactly the same way no matter which way the current flows. Try it !)
- When it is forward-biased, a silicon diode conducts, with a voltage drop of about 0.7V across it.
- When it is reverse-biased, it does not conduct (for low voltages, at any rate.)
- When forward-biased, a Shottky diode conducts, with a voltage drop of about 0.2V across it. Some Germanium diodes have a forward voltage drop of around 0.3V.

Worksheet 3

Diode clipping

One common use for a diode is that of clipping a signal voltage so that the positive, negative or both peaks are removed. Thus effectively limiting the excursion (peak or peak-peak value) of the signal. In this worksheet you will investigate three different types of clipper, displaying the input and output waveforms on your oscilloscope.



Over to you:

- Build each circuit in turn. In order, they are:
 - positive clipper;
 - negative clipper;
 - positive edge delayed clipper;
 - negative edge delayed clipper.
- For each circuit:
 - Connect the input to a 400Hz 20V peak-to-peak sinusoidal signal source.
 - Display at least two cycles of both the input and output waveforms on an oscilloscope. (Suitable settings are given below.)
 - Sketch the waveforms using the grids. Add labelled voltage and time axes .

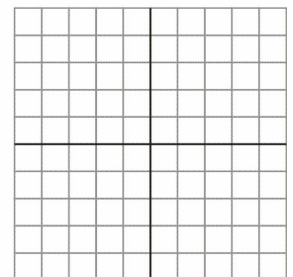
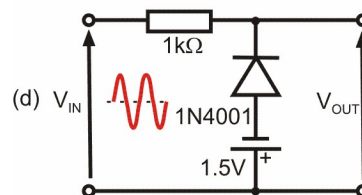
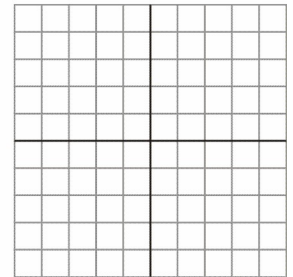
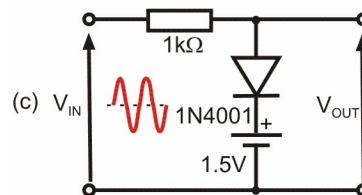
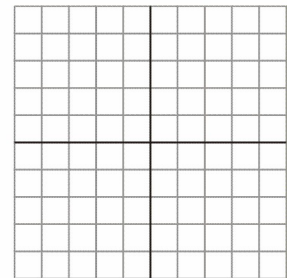
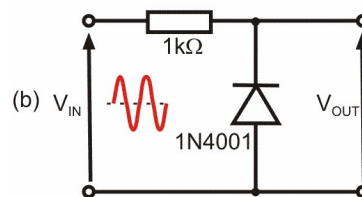
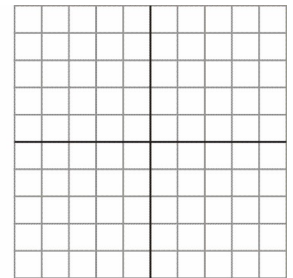
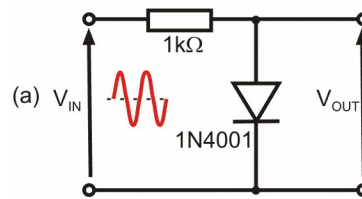

Suggested oscilloscope (or equivalent) settings:

Timebase - 1ms/div

Voltage range - Input A - $\pm 20V$ DC Input B - $\pm 20V$ DC

Trigger Mode - Auto **Trigger Channel** - ch.A

Trigger Direction - Rising **Trigger Threshold** - 0 mV

Worksheet 3

Diode clipping

For your records:

Practical applications of diode clipping circuits include:

- preventing audio signals from overdriving a radio transmitter, to avoid interference with other stations;
- producing controlled distortion in guitar amplifiers, and similar systems.

Three tasks:

1. The upper diagram shows the typical shape of the signal obtained from a negative clipper circuit. You set up a circuit like this, as circuit (b).

Explain the shape of the signal.

You should explain:

- why the positive portion of the signal copies almost precisely the input signal;
- why the negative portion of the signal is not exactly 0V.

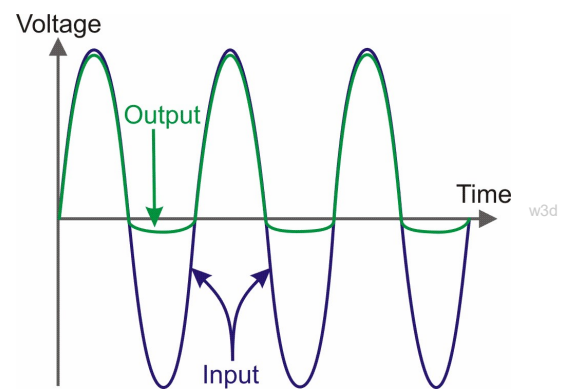

2. The lower diagram shows the output of a symmetrical clipping circuit fed with a sinusoidal input signal.

Design, build and test a diode clipping circuit that will produce an output signal like this, i.e. that will limit both the positive and negative amplitude of an input signal to a symmetrical output of approximately 1.4 V peak-to-peak.

(Hint: You will need to use two diodes!)

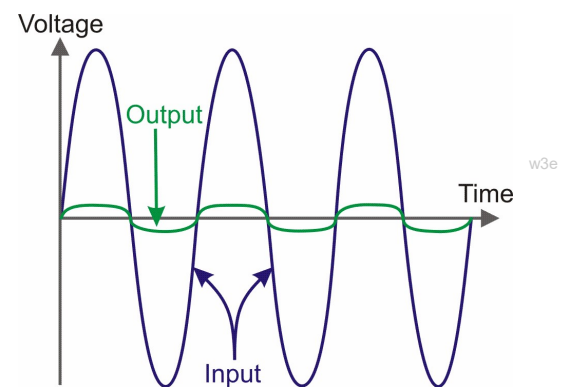

3. Design, build and test a diode clipping circuit that will limit both the positive and negative amplitude of an input signal to a symmetrical output of approximately 4.4 V peak-to-peak. (Hint: You will need to use two diodes and two batteries!)

Compare your solutions with those given on page 36.

Worksheet 4

Diode clamping

In Worksheet 3 you saw that the output signals from clipper circuits were no longer sinusoidal. This means that significant distortion has been introduced - the input contains only one frequency, 400Hz, but the output contains a host of higher frequencies as well. In some applications this can be desirable. However, in many applications we require waveforms to remain undistorted but become all positive or all negative. In other words, rather than swinging symmetrically around 0V, we need the waveform to be clamped totally above or totally below 0V. This can be achieved easily with the aid of a simple diode clamping circuit.

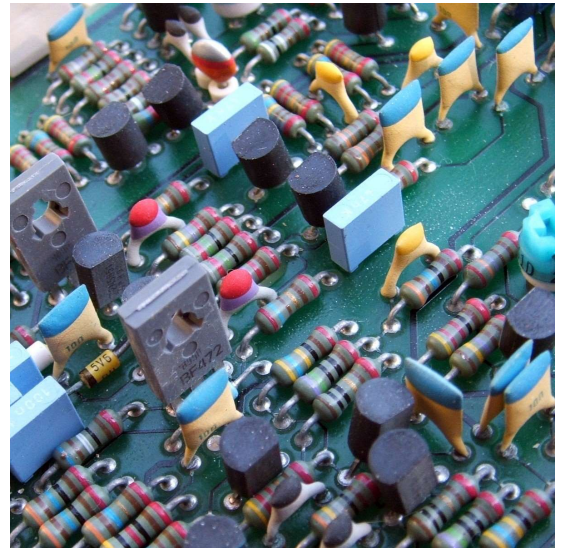

w4a

Over to you:

- Build each circuit in turn. Circuit (a) shows positive edge clamping, and circuit (b) negative edge clamping.
- For each circuit:
 - Connect the input to a 400Hz 20V peak-to-peak sinusoidal signal source.
 - Display at least two cycles of both the input and output waveforms on an oscilloscope. (Suitable settings are given below.)
 - Sketch the waveforms using the grids. Add labelled voltage and time axes.

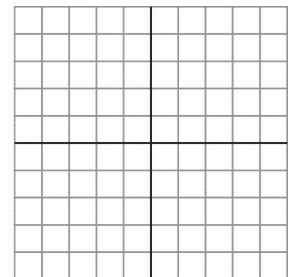
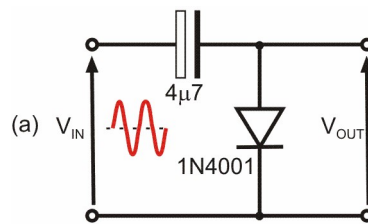

w4b

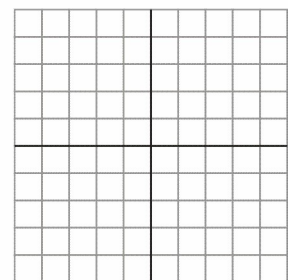
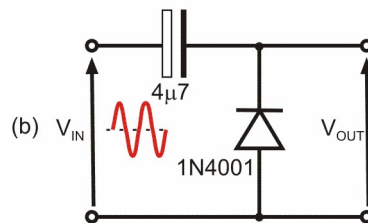

- Compare the waveforms produced with those you obtained for the clipping circuits in Worksheet 3.
- Do you notice any distortion in the output of the clamping circuits? How does this compare with the distortion produced by the clipping circuits in Worksheet 3?

Suggested oscilloscope (or equivalent) settings:

Timebase - 1ms/div (X multiplier x1)

Voltage range - Input A - $\pm 20V$ DC (Y mult. x1)

Input B - $\pm 20V$ DC (Y mult. x1)

Trigger Mode - Auto

Trigger Channel - ch.A

Trigger Direction - Rising

Trigger Threshold - 0 mV

Worksheet 4

Diode clamping

For your records:

- The diode clamping circuit is also known as a clamper, or as a DC restorer.
- It is designed to shift a waveform above or below a fixed DC voltage without altering its shape.
- The AC input signal has an average voltage of zero. The output has a non-zero average voltage.
- These circuits are used in test equipment, radar systems, electronic countermeasure systems, and sonar systems.

Principle of operation:

There are a number of ways to explain how this circuit works. Here is one:

- Capacitors block DC signals.
- In other words, their plates can sit at different DC voltages.
- Initially, the voltage difference across the plates is zero, (we assume.)
- It cannot change from this until some charge has flowed to / from the plates.
- In the negative half-cycle of the input:
 - plate L follows the input signal;
 - the diode conducts so that plate R cannot be more than 0.7V below Y.
- In the positive half-cycle of the input:
 - plate L again follows the input signal, and rises from $-V_S$ to $+V_S$;
 - the diode is reverse-biased, and cannot conduct;
 - plate R must follow it, as no charge moves to / from it;
 - the voltage at X rises from $-0.7V$ to $(+2V_S - 0.7)V$.

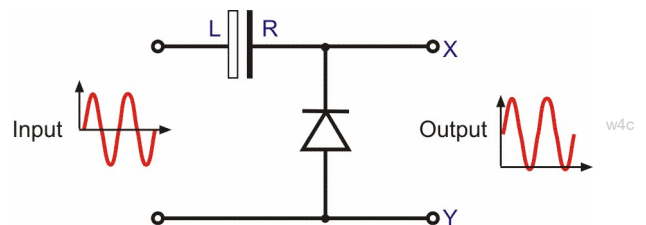

Two tasks:

1. What is the average voltage across the capacitor in an unbiased clamping circuit?

Explain your answer.

2. An extension of this idea is to add DC bias to the diode as shown in the circuit opposite.

What is the minimum output voltage produced by this circuit, assuming that a silicon diode is used?

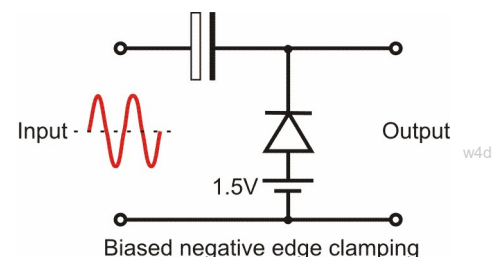

Compare your solutions with those given on page 36.

Worksheet 5

Half-wave rectifier

A common use for a diode is to convert alternating current (AC) to direct current (DC) in a **rectifier** circuit, exploiting the fact that a diode conducts only when the anode is more positive than the cathode.

Having produced a current that flows in only one direction, a large value capacitor, connected in parallel with the load, acts as a **reservoir** of charge and delivers current when the diode is not conducting.



Over to you:

- Build circuit (a).

The 12V AC power supply provides the input. The 270Ω resistor acts as the load for the rectifier circuit.

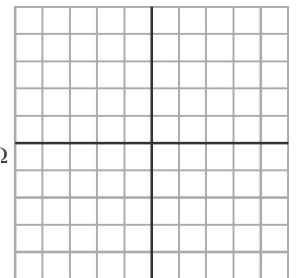
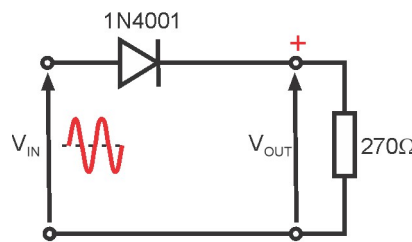

- Connect a DC voltmeter to measure the DC output voltage, V_{OUT} . Record it in the first line of the table.

- Connect a dual trace oscilloscope, using two 'x10' probes, so that Channel A displays at least two complete cycles of the input waveform and Channel B displays the corresponding output.

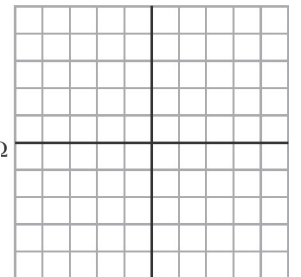
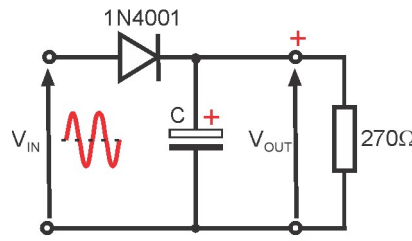

Connect the oscilloscope ground terminals to the negative rail of the circuit.

- Sketch the output waveform on the grid provided, and include labelled voltage and time axes.
- Modify the circuit by adding a 47μF reservoir capacitor, C, connected as in circuit (b), and sketch the output waveform.
- Again measure and record the output voltage, V_{OUT} .
- Repeat this process for the other values of capacitor C, given in the table.

Capacitor C	V_{OUT}
None	
47μF	
100μF	
1000μF	

Suggested oscilloscope (or equivalent) settings:

Timebase - 10 ms/div

Voltage range - Inputs A and B - ±5V DC with x10 probes

Trigger Mode - Repeat

Trigger Channel - ch.A

Trigger Direction - Rising

Trigger Threshold - 4 mV

Worksheet 5

Half-wave rectifier

So what?

The diode allows current to flow through it (and the load) in one direction only. It acts as a small resistor for currents trying to flow in one direction (when it is forward-biased,) and as a very large resistor for currents trying to flow in the other direction, (when reverse-biased.)

The first diagram shows a typical trace obtained from the first circuit. The AC input is turned into a DC output (rectified.) Notice that, while the output is DC (as it never crosses the 0V line,) it is not steady DC.

The second diagram shows the same signal, using a different time base setting for the oscilloscope (2ms/div.) This shows the rectification in more detail. In particular, notice that the DC output, in red, is approximately 0.7V lower than the AC input. The diode does not really conduct until the voltage across it reaches 0.7V. Once it starts to conduct, there is a 0.7V drop across the diode, leaving the DC output 0.7V below the AC input at all points.

The third diagram shows the effect of adding a smoothing capacitor. The output voltage is now both DC and steady.

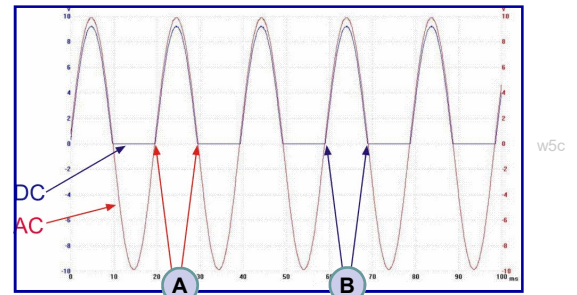

AC — A AC current changes direction here
DC — B DC current does not change direction

A closer view

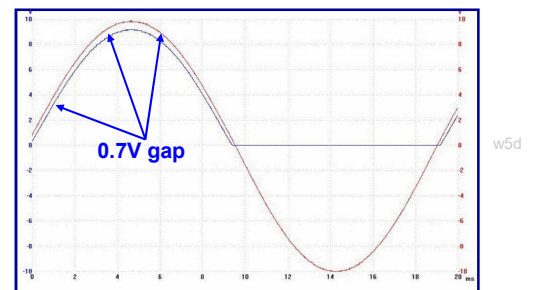

With the capacitor in circuit

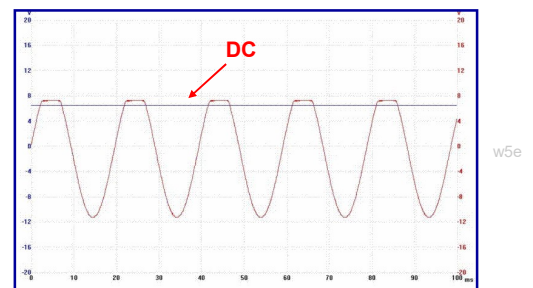

For your records:

- Explain the difference in the shape of the output waveform produced by circuit (a) and those produced by circuit (b).
- Which value of reservoir capacitance produced the highest value of DC output voltage? Why was this?

Worksheet 6

Full-wave (bridge) rectifier

The diode in a half-wave rectifier conducts for no more than 50% of the time. This is inefficient and requires large reservoir capacitors.

Most practical power supplies use four diodes to maintain the current flow through the load on both positive and negative half-cycles of the supply. In practice, they use either four individual diodes (as shown opposite) or a single component, a bridge rectifier, where the four diodes are encapsulated in a single package.

In this worksheet you investigate a full-wave rectifier, using four



w6a

Over to you:

- Build the circuit shown opposite, using the 12V AC power supply as the input once again.
- Measure the DC output voltage, V_{OUT} and record it in the first line of the table.
- Connect an oscilloscope to display at least two complete cycles of the **output** waveform.

Do not try to display the input waveform at the same time. The common ground connection will short-circuit one of the diodes!

The input waveform is the same as that displayed in the previous worksheet. Use the same time base and voltage sensitivity settings as before.

- Sketch the output waveform on the upper grid, with labelled voltage and time axes.
- Modify the circuit by adding a $47\mu\text{F}$ reservoir capacitor, C , connected as in the second circuit.
- Sketch the output waveform, with labelled axes.
- Measure and record the DC output voltage, V_{OUT} .
- Use the other capacitor values shown in the table. Measure and record the DC output voltage, V_{OUT} , for each.

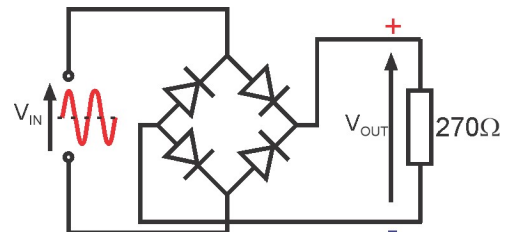

w6b

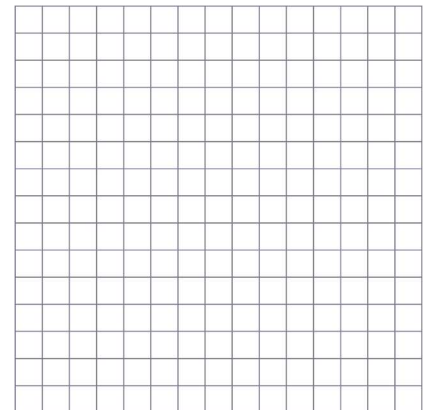

w6d

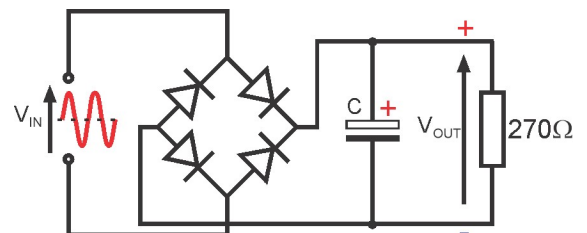

w6c

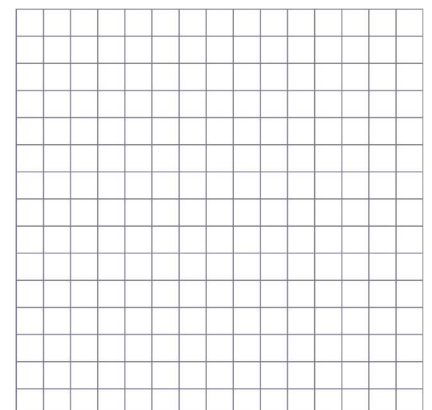

w6d

Capacitor C	V_{OUT}
None	
$47\mu\text{F}$	
$100\mu\text{F}$	
$1000\mu\text{F}$	

Worksheet 6

Full-wave (bridge) rectifier

So what?

The circuit diagram for the full-wave rectifier is shown opposite.

It was pointed out that you cannot measure the input and output waveforms simultaneously.

To do that, you would connect one channel to points **A** and **C** to measure the input, and the other to points **B** and **D** to measure the output. However, the oscilloscope has a common 0V connection between the two channels. This common connection would connect points **C** and **D** together, say, and thus short-circuit one of the diodes.

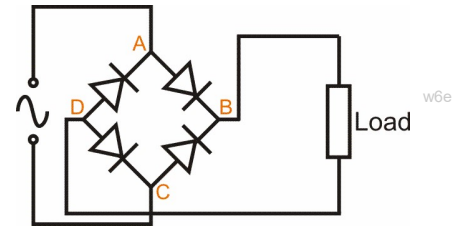

The three oscilloscope traces show typical waveforms for:

- the AC signal going into the full-wave rectifier,
- the DC output
- the effect of the reservoir capacitor.

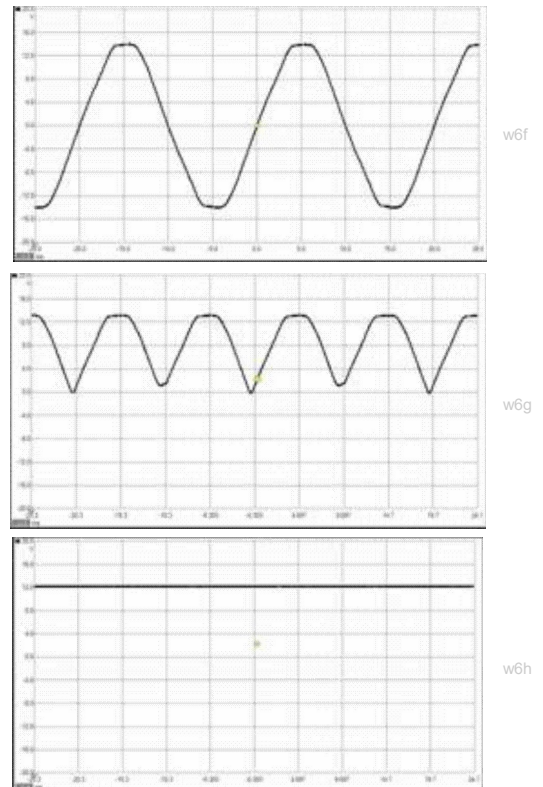

The DC output, in the middle trace, is an improvement on the half-wave output, in that current flows through the load throughout the AC cycle. Again, it is DC, because the trace never crosses the 0V line.

However, again, a reservoir capacitor is needed to provide **smooth** DC.

For your records:

- Explain the difference in the shape of the output waveform produced by the two circuits.
- Compare the performance of the full-wave rectifier with the half-wave rectifier:
 - Which gave the better performance?
 - In what way was it better?

Worksheet 7

Voltage multiplier

Voltage multipliers provide a convenient way of generating high voltages at relatively low current. They use a number of capacitors (of suitable working voltage) connected in series. Each capacitor charges to the peak value of the applied AC.

An alternative method uses a transformer but such arrangements tend to be bulky and expensive and so are used only where the current demand is much larger.

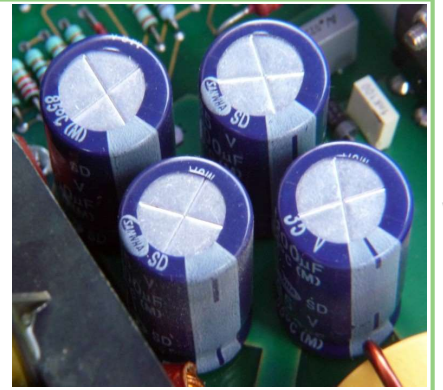

w7a

Over to you:

- Build each of the circuits shown opposite, in turn. The 12V AC power supply provides the input.

Circuit (a) is known as a half-wave doubler.

Circuit (b) is a full-wave voltage doubler.

Circuit (c) is a 'voltage tripler'.

Don't take these titles too literally! The actual performance depends on the load, in this case the 100kΩ resistor.

- Measure the DC output voltage, V_{OUT} , produced by each circuit using a multimeter set to the 200V DC range.
- Record your results in the table below.

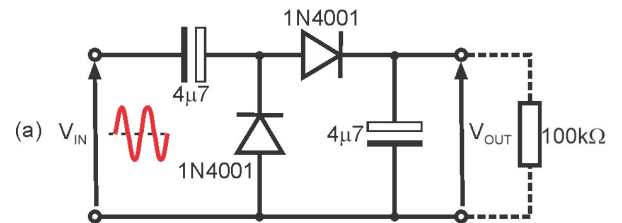

w7b

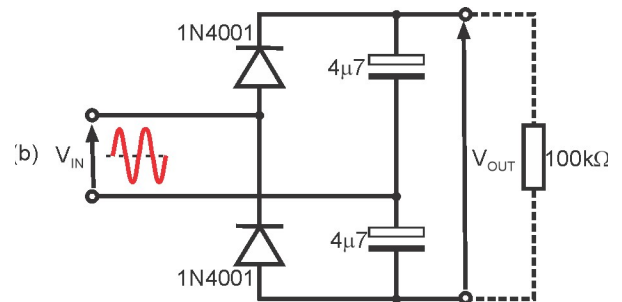

w7c

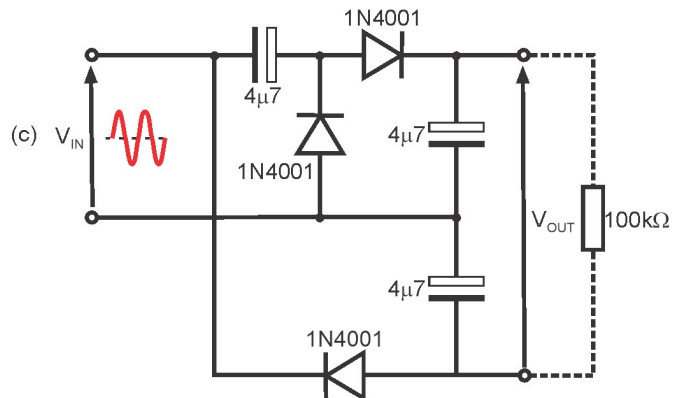

w7d

Multiplier circuit	V_{OUT}
(a)	
(b)	
(c)	

w7e

Worksheet 7

Voltage multiplier

So what?

Here is an explanation of the behaviour of circuit (a). It ignores any forward voltage drop across the diodes, and the effect of the current delivered to the load. It assumes that the capacitors are uncharged to begin with.

During the negative half-cycle of the power supply:

- point Q is 12V more positive than point P;
- diode X is forward-biased and so conducts;
- both ends of the diode sit at the same voltage;
- capacitor C_1 charges so that the right-hand plate is 12V higher than the left-hand plate.

The diagram opposite illustrates this situation.

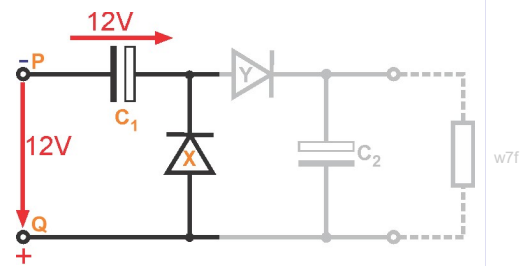

During the positive half-cycle of the power supply:

- point P is 12V more positive than point Q;
- diode X is reverse-biased and so does not conduct;
- the anode of diode Y is (12 + 12V) more positive than the cathode and so it conducts;
- both ends of the diode sit at the same voltage;
- capacitor C_2 charges so that the upper plate is 24V higher than the lower plate;
- The output voltage = 24V.

The second diagram illustrates this situation.

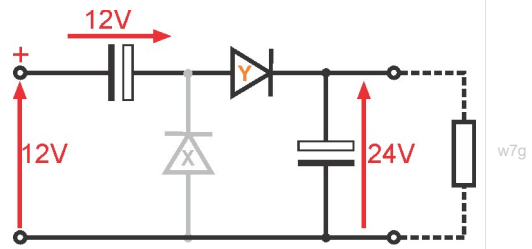

For your records:

- Circuit (b) is a double version of (a), and behaves in a very similar fashion. Write an explanation of how the circuit acts as a voltage multiplier.
- Comment on the performance of the multiplier circuits. Did you obtain the output voltages that you expected? If not, suggest reasons why this was not the case.
- Find out how a transformer could be used in conjunction with a rectifier circuit in order to produce a voltage ten times greater than the supply? Illustrate your answer with a labelled circuit diagram.

Worksheet 8

Thyristor

Semiconductor power control devices provide fast, efficient and reliable methods of switching high currents and voltages.

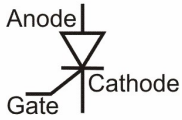

Thyristors, also known as silicon controlled rectifiers (SCR's,) are three-terminal devices that switch rapidly from a conducting to a non-conducting state.

In the 'off' state, they exhibit negligible leakage current, whilst in the 'on' state the device exhibits very low resistance. This results in little power loss within the device even when appreciable power levels are being controlled.

It is switched into the conducting state by applying a current pulse to the gate terminal. Then, the SCR remains conducting (i.e. it is **latched** 'on',) until the forward current is removed from the device.

In DC applications, this means interrupting (or disconnecting) the supply to return the device into its non-conducting state. However, with AC, the device automatically resets whenever the mains supply reverses. The SCR must then be re-triggered to conduct on the next half-cycle .



Over to you:

- Build the circuit shown opposite.
The 1kΩ resistor acts as the load .

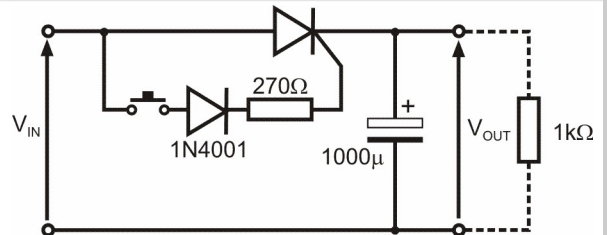

(a) DC behaviour:

- Connect a 12V **DC** power supply to provide the input, V_{IN} .
- Measure and record the output voltage, V_{OUT} , with the switch in the 'off' (open) position.
- Next press the switch and hold it 'on', (closed).
- Measure and record the output voltage, V_{OUT} , again.
- Finally, release the switch.
- Measure and record V_{OUT} , again.
- Momentarily disconnect and then re-connect the DC power supply.
- Repeat the output voltage measurement to check that the SCR has reset.

Switch S1	V_{OUT} (AC supply)	V_{OUT} (DC supply)
Open (off)		
Closed (on)		
Open (off)		

(b) AC behaviour:

- Connect a 12V **AC** power supply to provide the input, V_{IN} .
- Repeat steps 2 to 6, listed above, and complete the table with your results .

Worksheet 8

Thyristor

So what?

- Compare the performance of the circuit in the two situations. Suggest a reason for the difference.
- Research applications for a SCR - either DC or AC. Illustrate your answer with a labelled circuit diagram.

The thyristor is also known as a silicon controlled rectifier, which describes its DC behaviour very well. It is a special type of diode that allows current to flow only when a control signal is applied to its gate. Once turned on, the thyristor will not turn off, even after the gate signal has been removed, provided a sufficiently large current flows through it from anode to cathode.

The conditions needed to make the thyristor conduct, then, are:

- forward bias – the anode more positive than the cathode;
- a sufficiently large pulse of current flowing into the gate;
- a sufficiently large current then flowing from anode to cathode.

In the arrangement you used, when the switch S is closed, a current I_G flows into the thyristor gate. Providing this current is big enough, i.e. bigger than a value known as the **minimum gate current**, I_{GT} , typically between 0.1mA and 20mA, the thyristor will switch on.

Similarly, the voltage applied between the gate and the cathode, V_G , must be greater than a value, called the **minimum gate voltage**, V_{GT} , typically between 0.6V and 1.0V.

The thyristor then latches on, and a current, I_A , flows through the load even when switch S

is opened again. However, if this current drops below a minimum value, called the **holding current**, I_H , the thyristor switches off. Typically, I_H is around 10mA.

The ideal switching device is one which moves very rapidly from 'off' to 'on.' Thyristors make superb high power switching devices, as when they receive a sufficient gate pulse they move extremely quickly from the *forward-blocking* state, where the device is forward-biased, but not conducting, into the *conducting* state. As a result, they dissipate very little power in the process.

In the conducting state, there is a residual voltage drop of around one volt between anode and cathode, V_{AK} , so there is still some power dissipation, which means that the device may have to be cooled in some way (by use of a heat sink for example.)

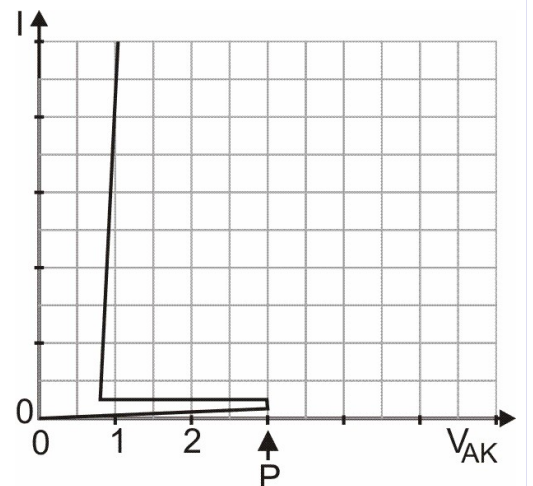
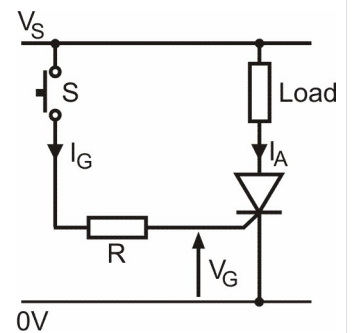

Worksheet 9

Zener diode characteristics

Zener diodes are silicon diodes that exhibit abrupt reverse breakdown at a pre-determined, low voltages (e.g. 4.7V, 5.6V or 9.1V).

When this happens, the voltage across the zener remains substantially constant regardless of the current flowing, provided its maximum ratings are not exceeded, .

In this worksheet you obtain the forward and reverse characteristics for a typical low-voltage Zener diode.



Over to you:

- Build circuit (a), shown below, to allow you to measure the **forward** characteristics of the 8.2V zener diode.
- Set the DC power supply for an output of 4.5V.
- Set the voltmeter to the 20V DC range and the ammeter to the 20mA DC range.
- Use the 'pot' to vary the voltage, V_F , applied to the diode from 0.1V to 0.7V in steps of 0.1V, and measure the forward current, I_F , at each step. Record your results in the table.
- Next invert the zener diode, and change the power supply voltage to 12V, as shown in circuit (b), . This allows you to measure the **reverse** characteristics of the two diodes.
- Change the ammeter to the 200 μ A DC range.
- Once again, use the 'pot' to vary the voltage applied to the diode, now called V_R , to the values given in the second table.
- Record them in the table.

Forward characteristics	
V_F	I_F
0	
0.1	
0.2	
0.3	
0.4	
0.5	
0.6	
0.7	

Reverse characteristics	
V_R	I_R
0	
5.0	
7.5	
8.0	
8.5	
9.0	
9.5	
10.0	

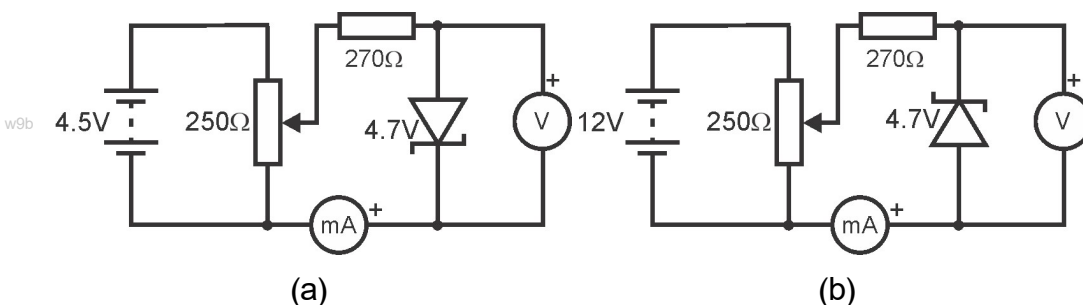

Worksheet 9

Zener diode characteristics

So what?

- Use the axes provided to plot your results as graphs of applied voltage against current for both the forward and reverse directions, for both zener diodes .
Notice that the voltage and current scales are different for the two directions.

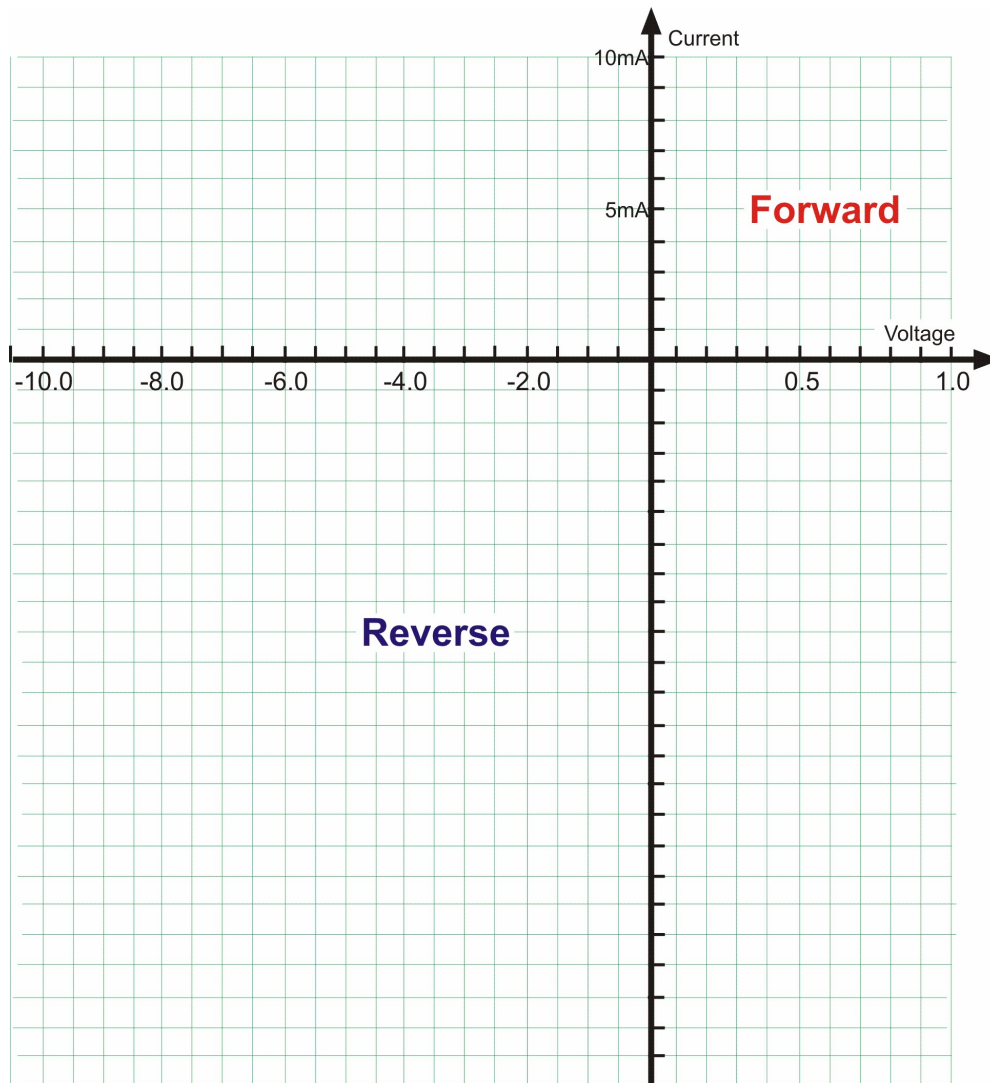

w9d

- Describe what the graph shows about the resistance of the zener diode in the different regions.
- What was the measured zener voltage?

For your records:

- Zener diodes are manufactured in different series, such as the BZX55C, the BZX85C and the 1N5300B series. What is the difference between these series?
- A zener diode can be used to provide surge protection in an electronic system. Find out how it does this. Illustrate your answer with a labelled circuit diagram.

Worksheet 10

Zener diode voltage regulator

A voltage regulator is designed to keep the power supply output voltage constant, despite changes in input voltage and load current.

A shunt voltage regulator can be as simple as a series resistor, and a Zener diode connected in parallel with the load. The Zener diode holds the load voltage constant over a wide range of input voltages (provided, of course, they exceed the Zener diode's reverse breakdown voltage!).

More complex voltage regulators use more complex techniques, but again, most rely on a Zener diode acting as an accurate voltage reference.

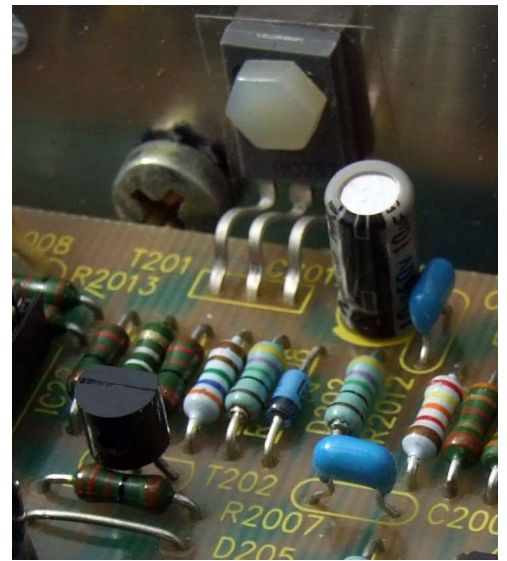

w10a

Over to you:

- Build the voltage regulator circuit shown opposite. The 1kΩ resistor represents the load connected to the voltage regulator circuit.
- Set the DC power supply to output 9V. With the 'pot', this provides a variable power supply voltage, V_{IN} , to the voltage regulator circuit.
- Adjust the 'pot' to vary the input voltage from 0 V to 8 V in steps of 0.5 V and, at each step, measure and record the input (power supply) voltage, V_{IN} , and output voltage, V_{OUT} in the table.
- Next, vary the load current by changing the load resistor to:
 - 270Ω;
 - 180Ω.
- For each, repeat the process outlined above and complete the appropriate table with your results.

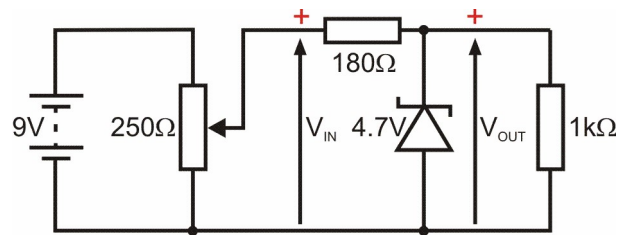

w10b

Load = 1kΩ		Load = 270Ω		Load = 180Ω	
V_{IN} /V	V_{OUT} /V	V_{IN} /V	V_{OUT} /V	V_{IN} /V	V_{OUT} /V
0		0		0	
0.5		0.5		0.5	
1.0		1.0		1.0	
1.5		1.5		1.5	
2.0		2.0		2.0	
2.5		2.5		2.5	
3.0		3.0		3.0	
3.5		3.5		3.5	
4.0		4.0		4.0	
4.5		4.5		4.5	
5.0		5.0		5.0	
5.5		5.5		5.5	
6.0		6.0		6.0	
6.5		6.5		6.5	
7.0		7.0		7.0	
7.5		7.5		7.5	
8.0		8.0		8.0	

Worksheet 10

Zener diode voltage regulator

So what?

- Plot your results as three separate graphs, one for each load resistor, on the grid below.

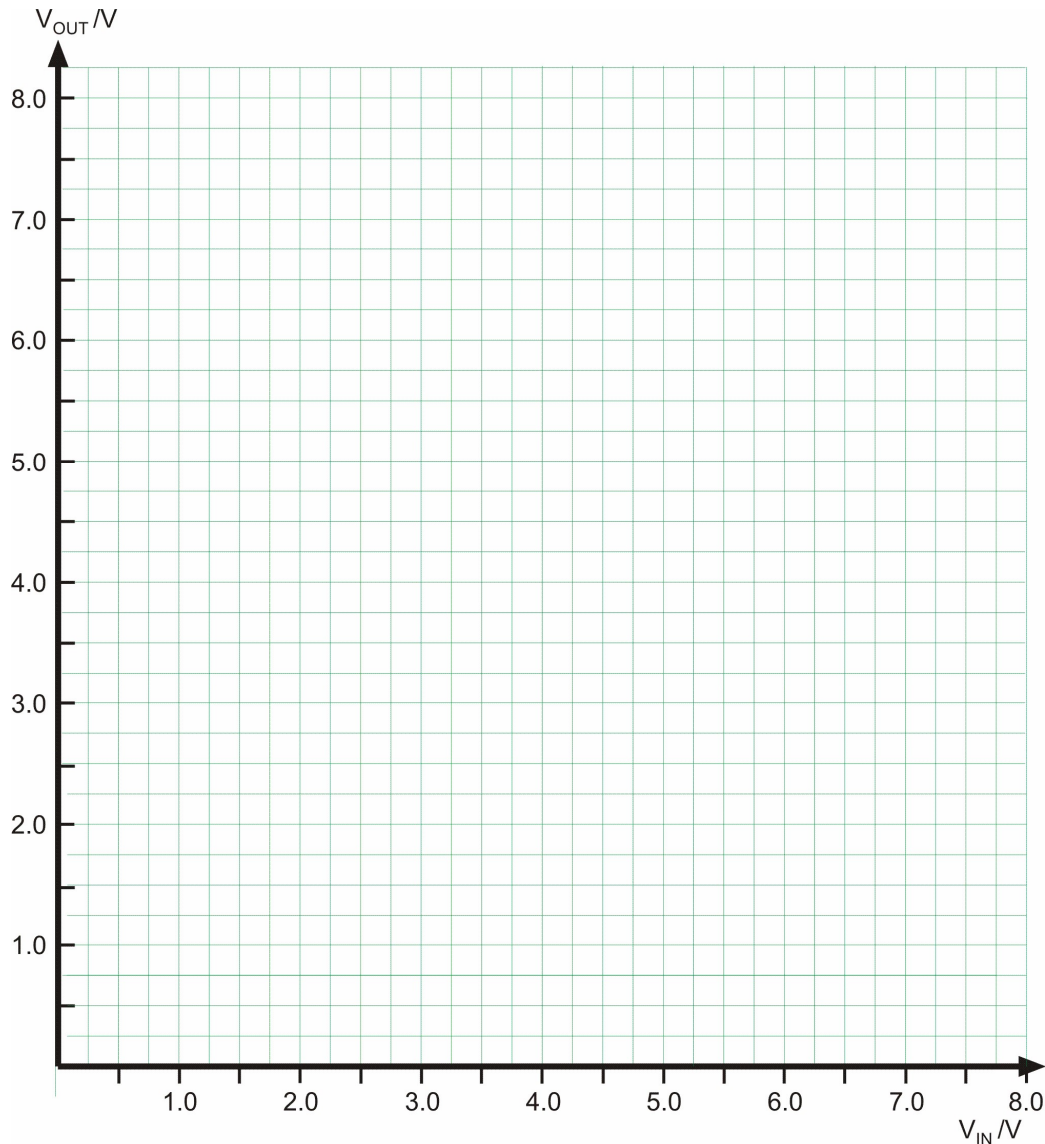

w10c

For your records:

- Line regulation measures how well a voltage regulator maintains the output voltage when the input (power supply) voltage changes. Comment on the performance of the voltage regulator circuit in terms of its line regulation.
- Load regulation measures how well a voltage regulator maintains the output voltage as the load current increases. Comment on the performance of the voltage regulator circuit in terms of its load regulation.
- What practical restrictions does these results place on the use of a simple shunt voltage regulator circuit?

Worksheet 11

Light emitting diodes

Light emitting diodes (LEDs) are used as general-purpose indicators. Compared with filament lamps they operate from significantly smaller voltages and currents, and are much more reliable.

Most LEDs provide a reasonable level of light output with a current of around 10mA and with a forward voltage drop of around 2V.

To limit the current flowing through an LED, a resistor is usually connected in series with it. The Locktronics LED carriers come with this resistor built in.



w11a

Over to you:

- Build the circuit shown opposite.
- Set the DC power supply to provide an output of 7.5V.
- Connect an ammeter, set to the 20mA DC range, to measure the current through the LED, and a voltmeter, on the 20V DC range, to measure the voltage drop across the LED and series resistor.

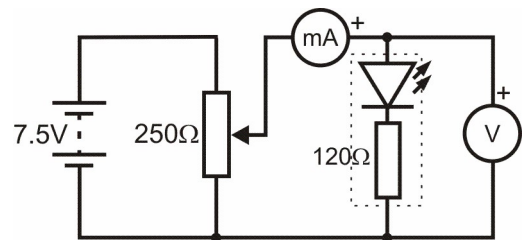

w11b

The 120 Ω series resistor is fitted inside the Locktronic LED carrier and so cannot be accessed separately.

- Adjust the 'pot' to vary the input voltage from 0V to 7.5V.
- Measure and record the voltage and current at which the LED:
 - first becomes illuminated;
 - provides a reasonably bright output.

LED state	LED (plus series resistor)	
	voltage	current
LED just producing visible light		
LED providing bright light		

Worksheet 11

Light emitting diodes

So what?

- The value of the protective resistor, R , may be calculated from the formula:

$$R = \frac{V - V_f}{I}$$

- where V_f is the forward voltage drop for the LED (typically around 2 V),
 - V is the supply voltage
 - I is the forward current.
- Use the formula: $P = I \times V$ to calculate the power dissipated in the LED, when it is lit. The voltage measurement you made in this investigation included the voltage drop across the series resistor, and so is not relevant here. Instead, use the typical voltage drop for the LED of 2V.
 - How does this compare with the power that would typically be supplied to a small filament bulb? In earlier work, you may have used a 6V 40mA bulb, for example.
 - Use your measured results to calculate the forward voltage of the LED. (Hint: You will need to use Ohm's law to calculate the voltage drop across the 120Ω series resistor).
 - LEDs are not good at handling reverse bias. A reverse bias of more than 5V can permanently damage a LED. Correct identification of the anode and cathode is therefore very important when using them in practical circuits:
The diagram shows the underside of a LED.
The anode (A) is the longer leg.
The cathode (C) is shorter, and is next to the flat edge of the LED's 'skirt'.
 - This means that specific care must be taken when using LEDs in AC circuits. They must be protected from excessive current with a series resistor, as in the DC case. In addition, they must be protected against reverse voltages. One way of doing this is to connect a semiconducting diode in 'inverse parallel' i.e. the other way round and in parallel. It acts to clamp the reverse voltage at 0.7V.

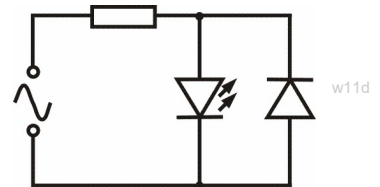
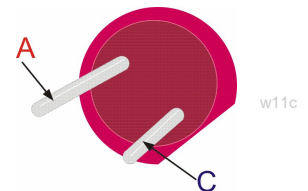

For your records:

- List at least FOUR advantages of LED indicators compared with small filament bulbs.
- LEDs are available in various colours. List these colours.

Compare your answers with those given on page 36.

About these questions

These questions are typical of those that you will be required to answer in the EASA Part-66 examination.

You should allow 15 minutes to answer these questions and then check your answers with those given on page 36.

Please remember that **ALL** these questions must be attempted **without** the use of a calculator and that the pass mark for all Part-66 multiple-choice examinations is 75%!

1. A diode will conduct when:

- (a) the anode is made positive with respect to the cathode
- (b) the cathode is made positive with respect to the anode
- (c) the anode and cathode are at exactly the same potential.

2. When a diode is forward biased it will:

- (a) exhibit a very low resistance
- (b) exhibit a very high resistance
- (c) exhibit no resistance at all.

3. Which one of the following gives the forward voltage normally associated with a silicon diode?

- (a) 0.1V
- (b) 0.6V
- (c) 2.0V.

4. In the reverse direction a diode will conduct:

- (a) a large amount of current
- (b) the same current as in the forward direction
- (c) hardly any current at all.

5. The typical forward voltage for an LED is approximately:

- (a) 0.7V
- (b) 2.1V
- (c) 6.3V.

w2b

6. The function of a reservoir capacitor in a power supply is to:

- (a) transform the input voltage to the required level
- (b) release charge when the rectifier diode(s) are non-conducting
- (c) convert half-wave operation to full-wave operation.

7. The output of rectifier will be kept more constant by using:

- (a) a relatively small value of reservoir capacitance
- (b) a relatively large value of reservoir capacitance
- (c) no reservoir capacitance at all.

w2b

8. The typical current flowing in an LED is in the region of:

- (a) 10mA to 20mA
- (b) 50mA to 100mA

(c) 200mA to 500mA.

9. Once triggered into the conducting state, an SCR will:

- (a) remain conducting as long as the SCR is held in a forward biased state
- (b) remain conducting even if the input voltage is reversed
- (c) rapidly switch into the 'off' state until the supply is disconnected and reconnected again.

10. A full-wave rectifier will operate:

- (a) only on positive half-cycles of the supply
- (b) only on negative half-cycles of the supply
- (c) on both positive and negative half-cycles of the supply.

11. When compared with silicon diodes, germanium diodes:

- (a) conduct at lower forward voltages but offer better reverse characteristics
- (b) conduct at higher forward voltages but offer better reverse characteristics
- (c) conduct at lower forward voltage but offer worse reverse characteristics.

12. Two silicon diodes are connected in anti-parallel across a signal path. These diodes will act as:

- (a) a clipping circuit
- (b) a clamping circuit
- (c) a rectifying circuit.

13. A series resistor is usually connected in series with an LED in order to:

- (a) act as a load
- (b) set the required value of operating current
- (c) prevent the LED from becoming reverse biased.

14. The connections to an SCR are labelled:

- (a) base, emitter, collector
- (b) anode, cathode, gate
- (c) source, gate, drain.

15. A typical application for a Zener diode is:

- (a) rectification
- (b) amplification
- (c) voltage regulation.

w2c

Answers are provided on page 36

About this course

Introduction

This workbook is intended to reinforce the learning that takes place in the classroom or lecture room. It provides a series of practical activities and investigations that complement syllabus section 4.1.1 of EASA Part-66 Module 4, Electronic Fundamentals.

Locktronics equipment makes it simple and quick to construct and investigate electrical circuits. The end result can look exactly like the circuit diagram, thanks to the symbols printed on each component carrier.

Aim

The workbook aims to introduce students to the basic underpinning principles and concepts of aircraft electrical and electronic equipment. It also provides a useful introduction to electrical measurements and the use of ammeters, voltmeters and oscilloscopes.

Prior Knowledge

Students should have previously studied (or should be concurrently studying) EASA Module 3 (Electrical Fundamentals) or should have equivalent knowledge at Level 3.

Learning Objectives

On successful completion of this course the student will have learned:

- how to connect a diode in forward bias and in reverse bias;
- three simple functional tests on diodes;
- how to obtain the current / voltage characteristics for a diode;
- to distinguish between silicon and germanium diodes using current / voltage characteristics;
- the meaning of signal voltage clipping;
- to set up circuits for positive and negative clipping, and positive edge and negative edge delayed clipping;
- design a symmetrical clipping circuit using two diodes;
- to distinguish between diode clipping and diode clamping;
- to set up diode circuits for positive edge clamping and negative edge clamping;
- to set up a half-wave rectifier circuit;
- to set up a full-wave rectifier using a four diode bridge circuit;
- to recognise the output waveforms for half and full-wave rectifiers;
- to compare the performance of half-wave and full-wave rectifiers;
- the use of reservoir capacitors in simple half-wave and full-wave power supplies;
- to set up voltage multiplier circuits (i.e. doublers, triplers and quadruplers);
- the conditions needed to make a thyristor (SCR) conduct;
- the need for a gate resistor, and the significance of minimum gate voltage and current for a thyristor;
- the use of silicon controlled rectifiers (SCR) in DC and AC power controllers;
- the basic forward and reverse characteristics of zener diodes;
- the use of zener diodes in simple shunt voltage regulators;
- the operation of light emitting diodes (LEDs) in DC and AC circuits.

The table below shows the parts needed for all 4 workbooks in the Electronic fundamentals series.

Qty	Code	Description	Qty	Code	Description
2	HP 2666	12V adjustable DC power supply	4	LK5603	Lead, red, 500mm, 4mm to 4mm stackable
1	HP 3728	AC power supply, 12VAC, 15A, UK	4	LK5604	Lead, black, 500mm, 4mm to 4mm stackable
1	LK2340	AC voltage source carrier	4	LK5607	Lead, yellow, 500mm, 4mm to 4mm stackable
1	LK3548	Fibre optic Transmitter	4	LK5609	Lead, blue, 500mm, 4mm to 4mm stackable
1	LK3982	Voltmeter, 0V to 15V	1	LK6202	Capacitor, 100uF, Electrolytic, 25V
1	LK4002	Resistor, 100 ohm, 1W, 5% (DIN)	1	LK6205	Capacitor, 1uF, Polyester
1	LK4003	Capacitor, 1000 uF, Electrolytic 30V	3	LK6206	Capacitor, 4.7uF, electrolytic, 25V
1	LK4123	Transformer, 2:1turns ratio	2	LK6207	Switch, push to make, metal strip
1	LK4663	Low power solar motor	1	LK6209	Switch, on/off, metal strip
3	LK5202	Resistor, 1k, 1/4W, 5% (DIN)	1	LK6214	Capacitor, VARIABLE, 0-200pF
3	LK5203	Resistor, 10k, 1/4W, 5% (DIN)	3	LK6216	Capacitor, 0.47 uF, Polyester
1	LK5205	Resistor, 270 ohm, 1/2W, 5% (DIN)	1	LK6218	Resistor, 2.2k, 1/4W, 5% (DIN)
2	LK5207	Resistor, 180 ohm, 1/2W, 5% (DIN)	1	LK6224	Switch, changeover, toggle
1	LK5208	Potentiometer, 250 ohm (DIN)	1	LK6224	Changeover switch
1	LK5209	Resistor, 5K6 ohm, 1/2W, 5% (DIN)	1	LK6232	Resistor, 500k, 1/4W, 5% (DIN)
2	LK5214	Potentiometer, 10k (DIN)	1	LK6234L	Op Amp Carrier (TL081) with 2mm to 4mm Leads
2	LK5218	Resistor, 100k, 1/4W, 5% (DIN)	1	LK6238	Resistor, 200k, 1/4W, 5% (DIN)
2	LK5224	Capacitor, 47uF, Electrolytic, 25V	1	LK6239	Capacitor, 1nF, Polyester
2	LK5240	Transistor RHF, NPN	2	LK6635	LED, red, 5V (SB)
1	LK5241	Transistor LHF, NPN	1	LK6706	Motor 3 to 12V DC, 0.7A
1	LK5242	Diode, germanium	1	LK6774	Fibre optic cable - 1m
4	LK5243	Diode, power, 1A, 50V	1	LK6860	AND gate carrier (ANSI)
1	LK5247	Zener diode, 4.7V	1	LK6861	OR gate carrier (ANSI)
1	LK5248	Thyristor	2	LK6862	NOT gate carrier (ANSI)
24	LK5250	Connecting Link	1	LK7409	AA battery holder carrier
1	LK5254	Zener diode, 8.2V	1	LK7483	1:1 transformer with retractable ferrite core
1	LK5255	Transistor RHF, PNP	2	LK8275	Power supply carrier with battery symbol
1	LK5256	Transistor LHF, PNP	1	LK8275	Fibre optic receiver
1	LK5266	Bridge rectifier	1	LK8492	Dual rail power supply carrier
1	LK5402	Thermistor, 4.7k, NTC (DIN)	2	LK8900	7 x 5 metric baseboard with 4mm pillars
			2	LK9381	Ammeter, 0mA to 100mA

Using this course:

It is expected that the worksheets are printed / photocopied, preferably in colour, for the students' use. Students should retain their own copy of the entire workbook.

Worksheets usually contain:

- an introduction to the topic under investigation and its aircraft application;
- step-by-step instructions for the practical investigation that follows;
- a section headed 'So What?' which aims both to challenge learners by questioning their understanding of a topic and also provides a useful summary of what has been learned. It can be used to develop ideas and as a trigger for class discussion.
- a section headed 'Questions' which provides further work for students to carry out. Answers to these questions are provided at the end of this workbook.

This format encourages self-study, with students working at a rate that suits their ability. It is for the tutor to monitor that students' understanding is keeping pace with their progress through the worksheets and to provide additional work that will challenge brighter learners. One way to do this is to 'sign off' each worksheet, as a student completes it, and in the process have a brief chat with each learner to assess their grasp of the ideas involved in the exercises that it contains.

Finally, a set of examination 'Revision Questions' has been provided to conclude the work on each topic. These questions are of mixed difficulty and are typical of those that students will face when they sit their Module 4 CAA examinations. It is recommended that students should attempt these questions under examination conditions and without the use of notes or calculators.

Time:

It will take most students between six and eight hours to complete the full set of worksheets. It is expected that a similar length of time will be needed to support the learning in a class, tutorial or self-study environment.

Worksheet	Notes for the Tutor	Timing
1	<p>In the first worksheet, students carry out some simple functional checks on a diode. A brief introduction to this activity could be useful and students should be reminded that diodes conduct current in one direction only with current flowing from anode to cathode when the former is made more positive than the latter.</p> <p>Tutors may wish to demonstrate the use of a multimeter with a diode check facility alternatively, where this feature is unavailable, tutors could show how forward and reverse resistance readings can be used to indicate the 'go/no-go' status of a diode.</p> <p>The method that students should adopt in this worksheet is simply a comparison of forward and reverse current. In the forward direction (with the anode of the diode made more positive than the cathode) a large current should flow whilst in the reverse direction (with the cathode made more positive than the anode) no current at all should flow.</p> <p>Tutors might find it useful to provide students with some defective diodes (i.e. open-circuit and/or short-circuit devices). Students should then be able to identify 'good' and 'bad' devices by applying the procedure that they have used in this worksheet investigation.</p>	30 - 45 minutes
2	<p>The practical exercise involves varying the forward and reverse voltage applied to two different types of diode and measuring the corresponding current flow.</p> <p>Students should record their measured values in a table and then use this data to plot the forward and reverse characteristics of each device. Note that the silicon diode will not conduct any measurable reverse current and that different voltages (and axes) are used for the forward and reverse directions.</p> <p>Students should have access to sample characteristics for a variety of common devices (e.g. 1N4001 and OA91) so that they can compare these with their own graphs.</p> <p>They should be invited to suggest the approximate forward conduction voltage for each diode. In the case of the silicon diode this should be approximately 0.6 V but for the germanium device it will be more difficult to identify the particular point at which conduction starts and students should find that this occurs in the range 0.1 V to 0.2 V.</p> <p>Students could also be asked to suggest applications for each type of device. Alternatively, tutors could invite students to suggest whether the devices are suitable for either 'power' or 'signal' applications.</p>	60 - 90 minutes

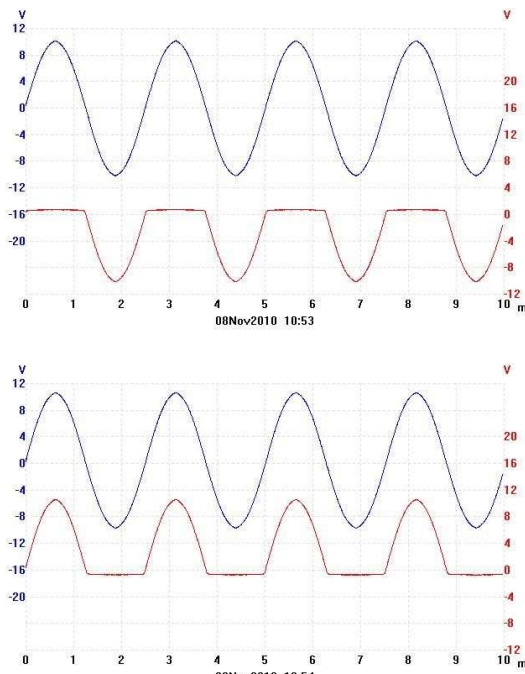
Worksheet	Notes for the Tutor	Timing
3	<p>In this worksheet students explore a practical application of diodes in shaping a signal waveform by clipping its positive or negative edge, or both.</p> <p>They start by constructing a positive clipping arrangement and then, by reversing the diode, produce a negative clipping circuit. In both cases the input to the circuit should be derived from a sinusoidal output of a waveform generator set to produce an output of 20 V pk-pk at 400 Hz. The signal generator should have an output impedance of 50Ω, or less (otherwise distortion and attenuation will start to become evident).</p> <p>Typical waveforms produced by the clipping circuits are shown below:</p>  <p>In the second part of the worksheet, students modify the basic clipping circuit so that its action is delayed. This is achieved by connecting a constant voltage source (in this case a 1.5 V battery) in series with the clipping diode. This effectively raises the threshold voltage at which the diode conducts.</p> <p>Finally, students are asked to devise, construct and test a symmetrical clipping circuit (which will use two diodes connected in anti-parallel). The required circuits (and waveforms) are shown on page 36.</p>	
		30 - 45 minutes

p31a

p31b

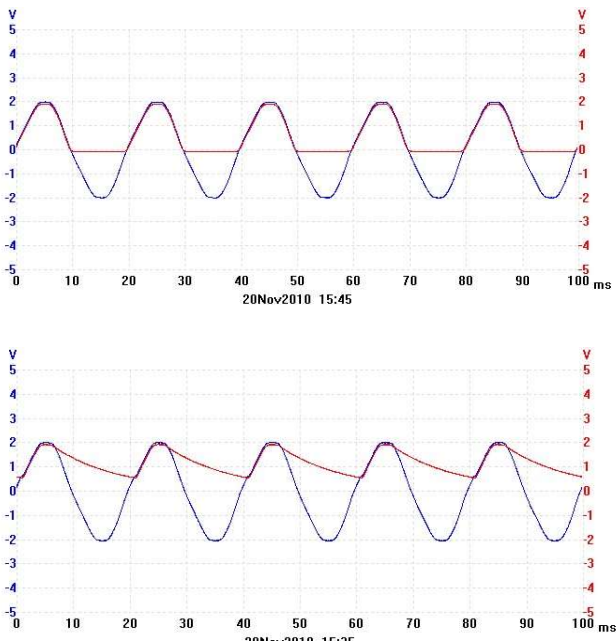
Worksheet	Notes for the Tutor	Timing
4	<p>Worksheet 4 is similar to worksheet 3 except that students construct and test circuits that will produce positive and negative edge clamping.</p> <p>Once again, the input to the circuit is derived from a waveform generator set to produce a sinusoidal output of 20V pk-pk at 400Hz. As before, the signal generator should have an output impedance of 50Ω, or less, to avoid excessive distortion and attenuation.</p> <p>Students should equate distortion to the addition of high frequencies. The tutor may need to explain this aspect of the worksheet.</p>	30 - 45 minutes
5	<p>Here, students investigate a most important application for diodes, converting alternating current (AC) to direct current (DC). They construct and test a simple half-wave rectifier arrangement.</p> <p>Initially they explore the operation of the circuit without a reservoir capacitor before going on to test it with four different values of capacitor. They obtain waveforms for each, sketching them using the grids provided.</p> <p>The input to the circuit is provided by the nominal 13.5 V 50 or 60 Hz AC power supply and not from a waveform generator, as this will not usually have a low enough output impedance.</p> <p>Note that 'x10' probes should be used to connect the oscilloscope or equivalent virtual instrument. Typical waveforms for this investigation are shown below. The first has no reservoir capacitor whilst the second has a 47 μF component.</p> <div style="text-align: center;">  </div> <p>Students are to investigate the effect of increasing the value of the reservoir capacitance on the amount of ripple produced by the circuit. More able students could be asked to measure the amount of ripple superimposed on the DC output and relate this to the time constant of the reservoir capacitor and load resistance.</p>	45 - 75 minutes

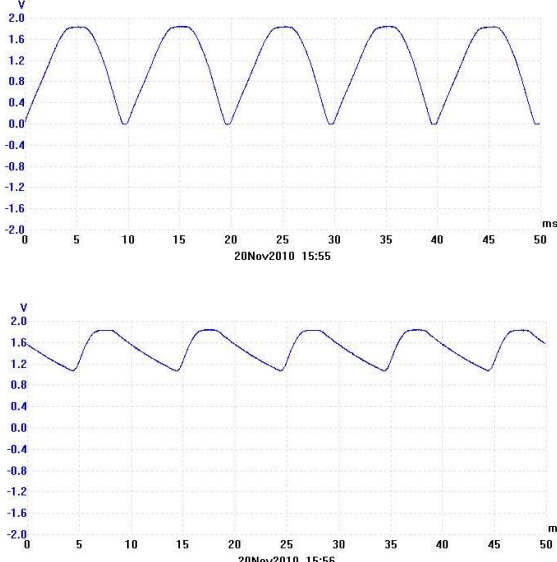
Worksheet	Notes for the Tutor	Timing
6	<p>In this worksheet students construct and test a simple full-wave rectifier arrangement. Once again, they initially explore the operation of the circuit without a reservoir capacitor before going on to test the circuit with four different values of reservoir capacitor. They obtain waveforms for each circuit, sketching them using the grids provided in the worksheet.</p> <p>The input to the circuit is once again to be derived from the nominal 13.5 V 50 or 60 Hz AC power supply (not from a waveform generator as this will not usually have a low enough output impedance). Note also that two series-connected 180 ohm resistors (each rated at 0.5 W) are used to place a load on the rectifier circuit. Also note that 'x10' probes should be used to connect the oscilloscope or equivalent virtual instrument.</p> <p>Important: Students should NOT attempt to make any connection to the AC input of the bridge rectifier as this will place a short-circuit across one of the diodes of the bridge! For this reason, students are only asked to investigate the output voltage from the bridge rectifier arrangement.</p> <p>Typical waveforms for this investigation are shown below. The first is where no reservoir capacitor is used whilst the second is for a 47 μF component.</p> <div style="text-align: center;">  </div> <p>It is important for the half-wave rectifier circuit used in the previous worksheet. They should, in particular, note that this rectifier functions on both positive and negative cycles of the input waveform and that the ripple frequency is twice that of the half-wave arrangement.</p> <p>As before, students are asked to explain the shape of the rectified waveform and the effect of increasing the value of the reservoir capacitance on the ripple produced by the circuit. More able students could be asked to measure the amount of ripple superimposed on the DC output and relate this to the time constant of the reservoir capacitor and load resistance.</p>	45 - 75 minutes

p33a

p33b

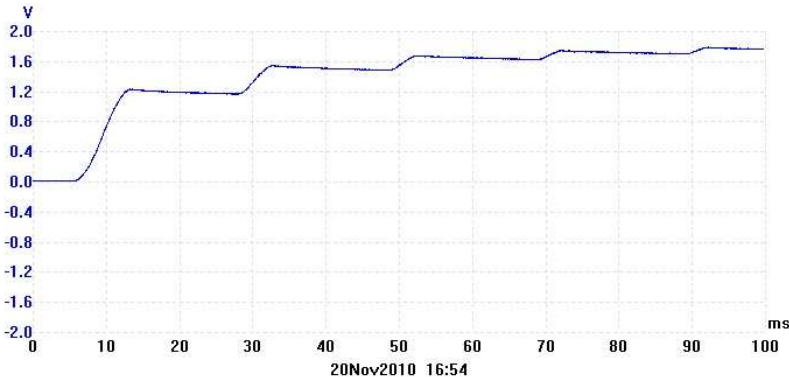
Worksheet	Notes for the Tutor	Timing
7	<p>In Worksheet 7, students investigate the operation of four different voltage multiplier circuits.</p> <p>They measure and record the DC output voltage produced by each arrangement when supplied from a nominal 13.5V 50 or 60 Hz AC source.</p> <p>Note that a single 10kΩ resistor is used to simulate the load on each of these multiplier circuits and that there is no need for students to attempt to display waveforms for these circuits.</p> <p>Tutors should discuss applications for voltage multiplier circuits and compare/contrast these with conventional transformer-rectifier methods of generating high voltages.</p>	20 - 30 minutes
8	<p>Here, students investigate the operation of a thyristor, or silicon controlled rectifier when supplied first with DC and then with AC.</p> <p>Students should be reminded about ideal switching circuits - that an ideal switch in the 'off' state has all the supply voltage across it, leaving no volts across a load in series with it, whereas in the 'on' state, it has no voltage drop across it, leaving the full supply voltage across the load.</p> <p>They will see that, once latched into the conducting state by applying sufficient current to the gate trigger, the SCR remains conducting until the forward current is removed from the device. This can be achieved in a number of ways. Once again, a 13.5V 50 or 60Hz AC supply is used for this investigation.</p> <p>More able students could be asked to investigate the triggering of the SCR when used on AC. A typical waveform obtained immediately after applying the gate trigger pulse is shown below:</p>  <p style="text-align: center;">20Nov2010 16:54</p>	30 - 45 minutes

p34a

Worksheet	Notes for the Tutor	Timing
9	<p>This practical task involves varying the forward and reverse voltage applied to a zener diode and measuring the corresponding current flow.</p> <p>Students record their measurements in the table provided and then use this data to plot the forward and reverse characteristics of the zener diode.</p> <p>Note that the zener diode will not conduct any measurable reverse current until the onset of breakdown and, beyond this point, the reverse current will increase very rapidly.</p> <p>Students should have access to sample characteristics for a variety of common zener diodes (e.g. BZY88 C4V7) so that they can compare these with their own graphs.</p> <p>Students verify the stated zener voltage by reference to the reverse characteristic that they have obtained. This investigation is then repeated with a device having a different zener voltage.</p>	30 - 45 minutes
10	<p>Students construct and test a simple zener diode shunt regulator circuit.</p> <p>They vary the DC input voltage and then measure and record the output voltage. In order to appreciate the effect of the load on the system performance, they repeat their measurements for three different values of load resistor.</p> <p>If desired, and where time permits, this investigation could be repeated with a device having a different zener voltage.</p>	30 - 45 minutes
11	<p>This final worksheet involves an investigation of the operation of a simple LED indicator.</p> <p>In Locktronics, this component is fitted with a protective $120\ \Omega$ series resistor, which has to be taken into account when calculating the forward voltage of the LED. Tutors may wish to provide a sample calculation showing how the value of series resistance is determined for a particular operating voltage and current.</p> <p>Students are asked to calculate the power needed to illuminate the LED and compare this with the power required to illuminate a small filament lamp.</p> <p>They then list the advantages of LED when compared with small filament lamps. Answers are provided on page 36.</p> <p>Students may find it difficult to assess when the LED actually first becomes illuminated. If this is the case, they should be asked to identify the point at which they consider the light output sufficient to be used as an indicator under normal lighting conditions.</p>	30 - 45 minutes

Worksheet 3

Task 2

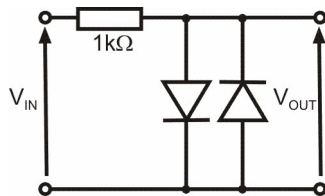

p36a

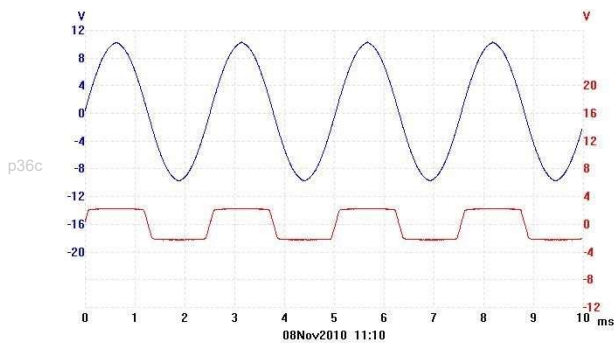

p36c

Task 3

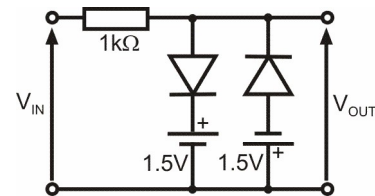

p36b

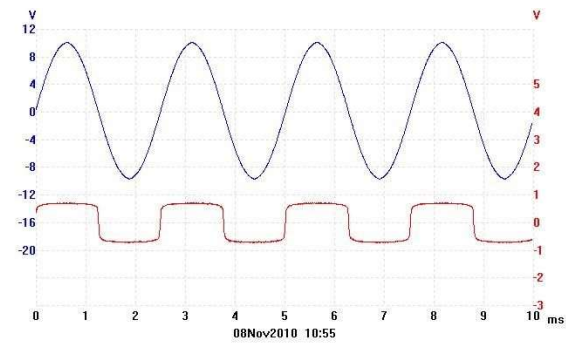

p36d

Worksheet 4

1. Average voltage across the capacitor is the same as the peak voltage of the input signal.
2. Minimum output voltage is $1.5 - 0.7 = 0.8V$.

Worksheet 11

1. Low voltage and low current operation; excellent reliability; small size; available in various colours; little heat produced
2. Red; green; blue; yellow

Revision question paper

- | | |
|---------|---------|
| 1. (a) | 2. (a) |
| 3. (b) | 4. (c) |
| 5. (b) | 6. (b) |
| 7. (b) | 8. (a) |
| 9. (a) | 10. (c) |
| 11. (c) | 12. (a) |
| 13. (b) | 14. (b) |
| 15. (c) | |

Version control



- 29 06 20 Diode characteristics: updated for Shottky diodes
- 31 07 23 Reformatted to new style
- 13 09 23 Various changes as power supply moved from 13.5V to 12V.
- 18 09 23
 - page 11 - 220uF deleted from table
 - Page 13 - 220uF deleted from table
 - Page 13 - 500ohm resistor in both circuit diagrams changed to 270 ohm
 - Page 13 - 13.5VAC changed to 12VAC
 - Page 28 - BOM update