

# Fundamentals of Battery Storage Technology

SAMPLE

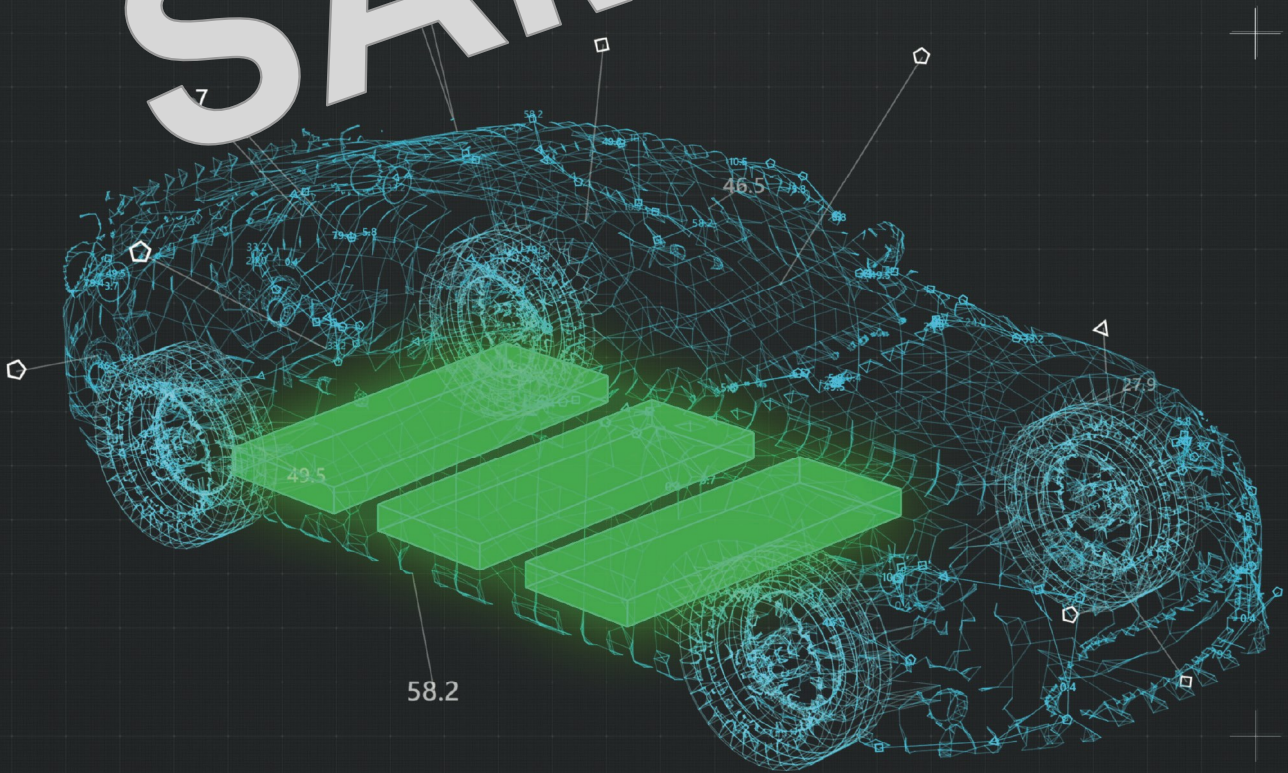

Introduction	Components
Worksheet 1	Relationship between current, resistance and voltage
Worksheet 2	Series connection of ohmic resistances
Worksheet 3	Parallel connection of ohmic resistances
Worksheet 4	Nominal voltage and capacity of voltage sources
Worksheet 5	Internal resistance of voltage sources
Worksheet 6	Series connection of voltage sources
Worksheet 7	The capacitance of a battery module
Worksheet 8	The energy density of battery modules
Worksheet 9	The Ri efficiency of a battery module
Worksheet 10	The total efficiency of a battery module
Worksheet 11	The charging process of a capacitor
Worksheet 12	The discharge process of a capacitor
Worksheet 13	I-V characteristics of the single NiMH battery module
Worksheet 14	I-V characteristics of the NiZn battery module
Worksheet 15	I-V characteristics of the LiFePo battery module
Worksheet 16	I-V characteristics of the lead battery module*
Worksheet 17	I-V characteristics of the lithium-polymer battery module**
Worksheet 18	I-V characteristics of the triple NiMH battery module
Worksheet 19	The charging process of the NiMH battery
Worksheet 20	The charging process of the NiZn battery
Worksheet 21	The charging process of the LiFePo battery
Worksheet 22	The charging process of the lead battery*
Worksheet 23	The charging process of the lithium-polymer battery**
Worksheet 24	The discharging process of a battery module
Worksheet 25	Hydrogen production in the reversible hydrogen fuel cell
Worksheet 26	Characteristic curve of the electrolyzer
Worksheet 27	Hydrogen consumption of a fuel cell
Worksheet 28	Characteristic curve of the fuel cell
Worksheet 29	The efficiency of the hydrogen fuel cell
Worksheet 30	Operation of the electric car with several battery modules
Worksheet 31	Operation of the electric car with the reversible fuel cell

\* Expansion Lead-battery module is required for this experiment.

\*\* Expansion Lithium-Polymer-battery module is required for this experiment.

### Base unit EMobility 1801-07

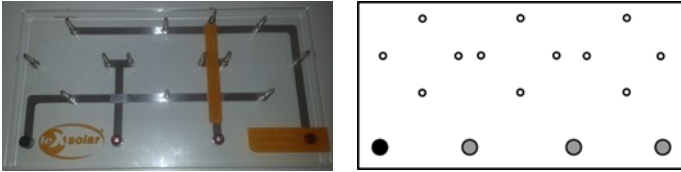

The base unit is a breadboard where up to 3 components can be plugged in a series and parallel connection. The current flows along the wires on the bottom side. To connect the components on the base unit with other components, there are 4 terminals at the lower end.

### Expansion ChargerModule 9100-13 (not included—accessories pack required):

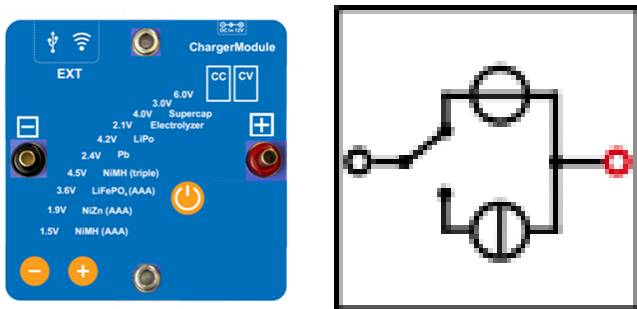

The ChargerModule is a universal battery charger for all batteries, the capacitor and the reversible fuel cell are included ready-to-go. With the additional fixed-voltage outputs constant voltage of 3V or 6V can be applied. To operate the ChargerModule first the power adapter must be plugged in and connected to the input jack on the top right of the module. The charging program is selected by the "+" and "-" button and is displayed by the LEDs. The Power button is used to switch on the ChargerModule. During the charging process, the Power Enable LED flashes once per second and all keys are locked. Pressing the Power Enable button for 0.5s cancels the selected program. When the charging process is complete, there occurs an acoustic signal (3 loud "medium high" beeps, a total of about 2 seconds) and the Power Enable LED is continuously lit.

The ChargerModule provides a constant voltage (cv-mode) or constant current (cc-mode) depending on the charge program. For most battery modules a combined cc/cv-mode is applied. The top LEDs (CC/CV) indicate the applied charging mode.

For open-circuit (for example no battery module is connected to the charger) five high beeps occur and the charging program is terminated immediately. If the voltage of the connected battery module is higher than the maximum charging voltage (for example, if an incorrect battery is connected) or below the specified end-of-discharge voltage the charging program is also terminated. Independent of the connected module the charger switches off after 1 hour to prevent accidental overloading of the battery module. The following charging programs can be selected:

### **NiMH (AAA):**

- Only cc-mode (charge current  $I = 250 \text{ mA}$ ) without cv-process
- Upper voltage limit: 1.6V

Lower voltage limit: 1V

### **NiZn (AAA):**

- Starts with cc-mode ( $I=250\text{mA}$ ) up to a switching voltage  $V=1.8\text{V}$
- After reaching the threshold voltage switch to cv-mode, switch-off at a current of 100mA
- Upper voltage limit: 2V

Lower voltage limit: 1.3V

### **LiFePo (AAA):**

- Starts with cc-mode ( $I=200\text{mA}$ ) up to a switching voltage  $V=3.6\text{V}$
- After reaching the threshold voltage switch to cv-mode, switch-off at a current of 100mA
- Upper voltage limit: 3.7V

Lower voltage limit: 2.8V

### **NiMH (triple):**

- Only cc-mode (charge current  $I = 250 \text{ mA}$ ) without cv-process
- Upper voltage limit: 4.8V

Lower voltage limit: 3V

### **Pb:**

- Starts with cc-mode ( $I=500\text{mA}$ ) up to a switching voltage  $V=2.35\text{V}$
- After reaching the threshold voltage switch to cv-mode, switch-off at a current of 200mA
- Upper voltage limit: 2.45V

Lower voltage limit: 1.8V

### **LiPo:**

- Starts with cc-mode ( $I=500\text{mA}$ ) up to a switching voltage  $V=4.1\text{V}$
- After reaching the threshold voltage switch to cv-mode, switch-off at a current of 200mA
- Upper voltage limit: 4.3V

Lower voltage limit: 3V

### **Electrolyzer:**

Only cv-mode ( $V=2.1\text{V}$ )

### **Supercap:**

- Only cv-mode ( $V=2.1\text{V}$ ), switch-off at a current of 50mA
- Upper current limit: 2A

Switch-off after 10min, independent of current

### **3V:**

Constant voltage of 3V

### **6V:**

Constant voltage of 6V

# Introduction

## Components

### Expansion AV-Module 9100-03 (not included—accessories pack required):

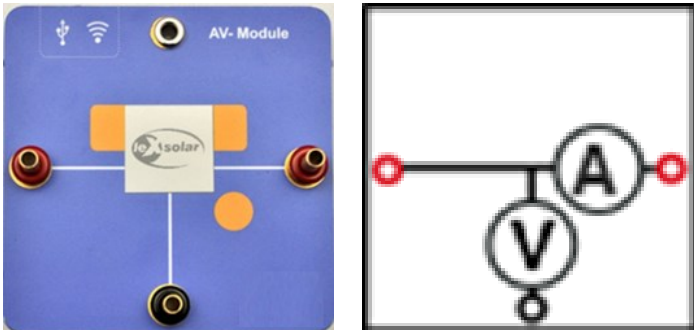

The AV-Module is a combined voltage and current meter. It holds 3 buttons, whose features are described in the display respectively. By pushing a random button the module will switch on. When the display does not show anything or the word „Bat“ is shown, it is necessary to change the batteries in the back (2 x AA batteries 1.2 to 1.5V; Take care of the polarity marked on the bottom of the battery case! Do not touch the button while inserting the batteries).

With the top right button the measuring mode can be switched between voltage mode, current mode or combined voltage-current mode. Both measurement mode and required cable connection will be indicated by the circuit symbols on the display. Take care that in voltage mode no current is applied to the right jack. In the combined mode the voltage can be measured with the right jack as well as with the left one. The influence of the internal resistance of the current measurement is compensated internally. The measured values are signed. When the positive pole is connected to a red jack and the negative pole is connected to the black jack, the value of the voltage will be positive. When current is applied from the left to the right, the current value will be positive, as well. The other way around, the algebraic sign changes.

After 30 min without pushing a button or after 10 min of measuring a constant value, the module will switch off automatically. It can measure voltages up to 12 V and currents up to 2 A. In case of exceeding one of the values, the module interrupts the current flow and shows “overcurrent“ or “overvoltage“. This error message can be confirmed by touching a button. The module will resumes measuring, when the values attain acceptable values.

### Specifications:

#### Voltage metering:

- range: 0...12 V
- accuracy: 1 mV
- automatic shutoff in case of overvoltage >12 V

#### Current metering:

- range: 0...2 A
- accuracy: 0,1 mA (0...199 mA) and 1mA (200 mA...1 A)
- automatic shutoff in case of overcurrent >2 A
- internal resistance <0,5 Ohm (0...200 mA); <0,2 Ohm (200 mA...2 A)

### Resistor plug module, triple (1800-01 ) with resistor plug elements

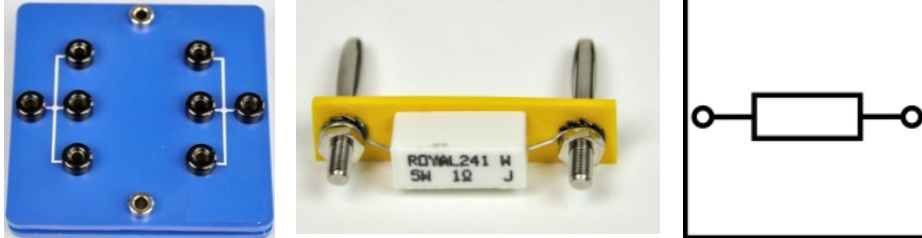

With the resistor plug module and the belonging resistor plug elements parallel connection and series connection of resistors are possible. For parallel connection use one resistor module (triple) with three slots. For series connection use two triple resistor modules. The following resistor plug elements are included:

1 x R=1Ω	1800-03
2 x R=10Ω	1800-05
1 x R=100Ω	1800-04

### Potentiometer module 110Ohm Pro 1100-62

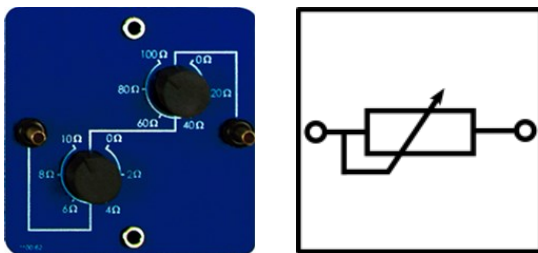

The potentiometer module holds a 0-10-Ω-potentiometer and a 0-100-Ω-potentiometer. Both are serially connected, so that the potentiometer can attain resistances between 0 Ω to 110 Ω. The measuring error amounts to 0.5 Ω for the small resistor and 3 Ω at other one. The maximum current amounts to 1A.

### Capacitor module 1118-11

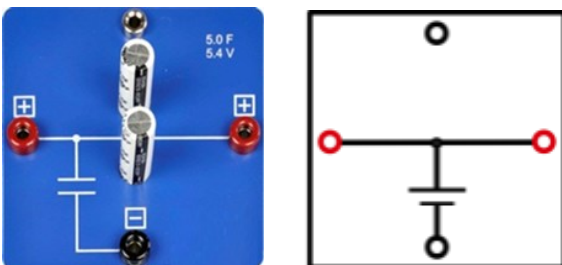

The capacitor module consists of 2 series-connected capacitors. Charging voltages for the capacitor should not exceed 5 V. It is possible to short-circuit the capacitor to discharge, because there are fuses to avoid damages.

#### Specifications:

Capacitance: 5 F  
Maximum voltage: 5,4 V

# Introduction

## Components

### NiMH-battery module, single L2-04-021 with mount 1800-08

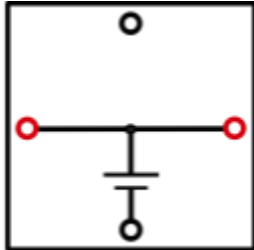

#### Specifications:

V=1,0V...1,35V  
End-point voltage: 1V  
Max. charging voltage: 1,6V

### NiMH-battery module, triple 1118-09

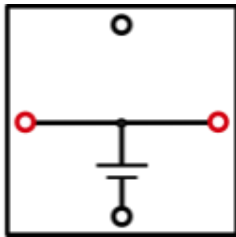

#### Specifications:

V=3V...4,05V  
End-point voltage: 3V  
Max. charging voltage: 4,8V

### LiFePo-battery module 1801-06

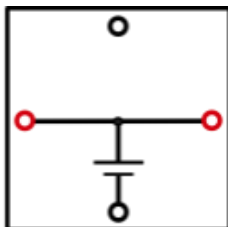

#### Specifications:

V=3,2V...3,4V  
End-point voltage: 2,8V  
Max. charging voltage: 3,6V

# Introduction

## Components

### NiZn-battery module 1801-06

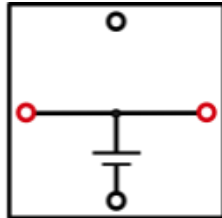

#### Specifications:

V=1,3V...1,8V  
End-point voltage: 1,3V  
Max. charging voltage: 1,9V

### Expansion Lead-battery module 1800-13 (not included—accessories pack required):

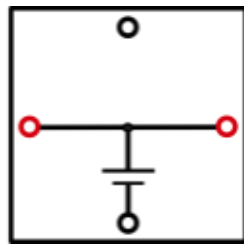

#### Specifications:

V=1,9V...2,15V  
End-point voltage: 1,9V  
Max. charging voltage: 2,35V

### Expansion Lithium-Polymer-battery module 1800-07 (not included—accessories pack required):

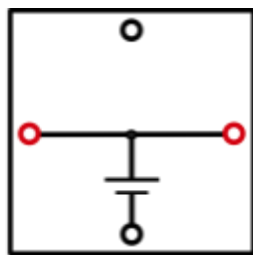

#### Specifications:

V=3V...4,2V  
End-point voltage: 3V



**Expansion Battery adapter cable 1800-09 (not included—accessories pack required):**

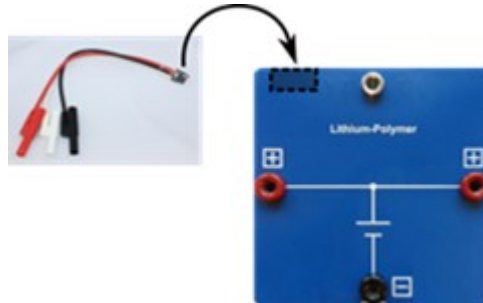
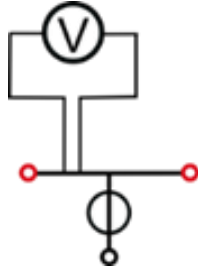

All battery modules are equipped with an additional connection for the four-point measurement. The adapter cable is connected with the black connector to this port:

To measure the voltage, the red and the black cable are connected with the measurement device. For measuring the resistance the white cable instead of the red is used.

**Reversible fuel cell (L2-06-067)**

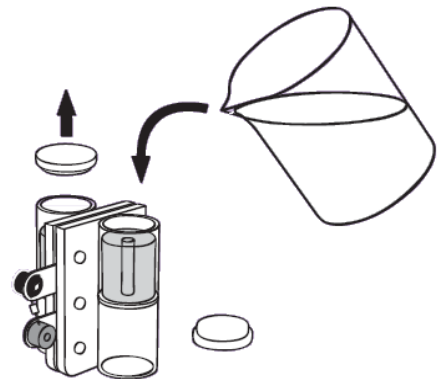
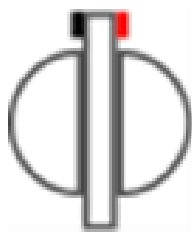

The reversible fuel cell consists of an electrolyzer and a fuel cell. To fill the reversible fuel cell you should proceed in the following way:

Fill the rev. fuel cell with distilled water as shown in the alongside figure.

Fill both storage cylinders up to the top of the tubules, which are inside the cylinders.

Knock the rev. fuel cell slightly on the table.

Continue filling in water until it flows through the tubules.

Close the storage cylinders with the plugs and turn over the rev. fuel cell (the plugs must be on the bottom).

**!! Advice:** To charge the reversible fuel cell the applied voltage should not exceed 1.5 V. Otherwise the resulting current could exceed 1 A, which would damage the fuel cell.

### Electric model car with battery adapter 1801-02

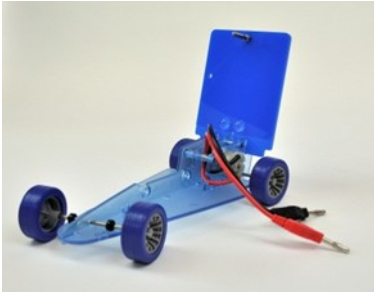

The electric model car can be used with the reversible fuel cell or the battery modules. The fuel cell can be plugged directly onto the car. The battery modules can be plugged with the adapter onto the car.

The car will move when both cables are connected with the voltage source. There will be a short circuit when the wires are held during the short circuit.

# Worksheets

## Relationship between current, resistance and voltage

### Task

Examine the relationship between voltage, current and resistance in a simple electrical circuit.

### Setup

### Equipment required

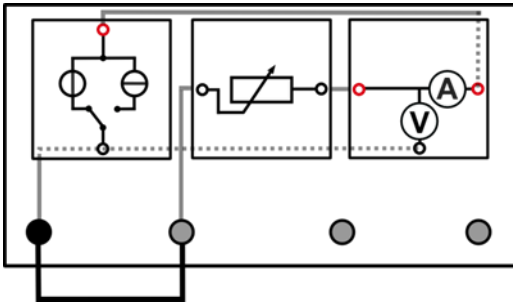

- base unit
- 1 ChargerModule
- 1 Potentiometer module
- 1 AV-Module
- 1 cable

### Procedure

1. Set up the experiment according to the circuit diagram. The Charger module is plugged into the base unit rotated by 90 ° (see sketch). Use the ChargerModule with constant voltage mode at 6V. For handling instructions see page 5.
2. Measure current I and voltage V for different resistances R at the potentiometer (for values see table). Use the AV-Module in voltage-current-mode. For handling instructions see page 7.
3. Note your measured values in the table.

### Data

R (Ω)	100	80	60	40	20
V (V)					
I (mA)					
V/I (Ω)					

### Evaluation

1. Calculate for each measuring point the ratio V/I and note your values in the table.
2. Which law reflects your findings? Illustrate these principles using data from the table.

---

---

---

---

## Series connection of ohmic resistances

### Task

Examine the series connection of ohmic resistances.

### Setup

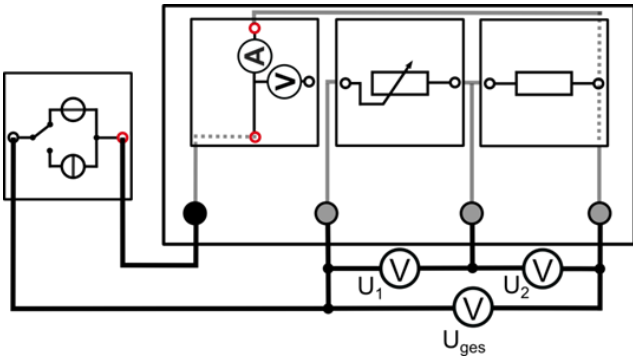

### Required devices

- base unit
- 1 ChargerModule
- 1 Potentiometer module
- 1 resistor module, triple
- 1 resistor plug element (R=100Ω)
- 1 AV-Module
- 4 cables

*Additionally needed:*

- 1 voltage measurement device

### Execution

1. Set up the experiment according to the circuit diagram. Use the ChargerModule with constant voltage mode at 6V. For handling instructions see page 5.
2. Adjust the resistance R of the potentiometer to a value of  $R_{Pot}=100\Omega$  and use the resistor plug element of  $R_S=100\Omega$  at the triple resistor module.
3. Measure each voltage V and current I over both resistances ( $V_{tot}$ ) and the single voltage ( $V_1, V_2$ ).

Note: The AV-Module is plugged into the base unit rotated by  $90^\circ$  (see sketch). It is used in current-mode. If no further measurement device is available, you can use the AV-Module in voltage mode to measure the voltage. For this purpose the slot of the AV module should be electrically bridged using a cable. For handling instructions see page 7.

4. Repeat your measurement for further resistance values at the potentiometer (see table).
5. Note your measured data in the table.

$R_S (\Omega)$	100	80	60	40	20
$V_1 (V)$					
$V_2 (V)$					
$V_{tot} (V)$					
$I (mA)$					
$R_{ges} = V_{tot} / I$ ( $\Omega$ )					

## Series connection of ohmic resistances

1. Calculate each the ratio  $R_{tot}=V_{tot}/I$  and note your values in the table above.
2. Calculate each the sum of the single voltages ( $V_1 + V_2$ ) and compare it the voltage over both resistances ( $V_{tot}$ ).
3. What is the influence of the resistance on the current  $I$  and the voltages  $V_1 + V_2$ , respectively  $V_{tot}$ ?
4. What is the connection between the total resistance  $R_{tot}$  and the single resistances? Formulate a law for the calculation of the total resistance in a series connection of resistances.

2.

	$V_1 + V_2$	$V_{tot}$
$R_{Pot} = 100\Omega / R_S = 100\Omega$		
$R_{Pot} = 80\Omega / R_S = 100\Omega$		
$R_{Pot} = 60\Omega / R_S = 100\Omega$		
$R_{Pot} = 40\Omega / R_S = 100\Omega$		

3.

---

---

---

---

---

---

---

4.

---

---

---

---

---

---

---

The full version of this curriculum is available upon purchase of the kit.

Please see contents for a full list of experiments from the full version.